

BDW16DW

Ce produit à double paroi est conçu pour les applications exigeant une efficacité thermique élevée et une détection de fuite avancée. Sa conception offre les mêmes avantages que les autres BPHE de SWEP en termes de performance et de compacité.



Spécifications de base

Nombre de plaques max. (NoP)	140
Débit volumétrique max.	11,3 m ³ /h (13.21 gpm)
Volume du canal	0.061/0.061 dm ³ (0.0022/0.0022 ft ³)
Matières	Plaques en acier inoxydable 316, brasage cuivre
Poids sans les connexions	1.55+(0.22*NoP) kg 3.42+(0.485*NoP) lb

Les dimensions standard

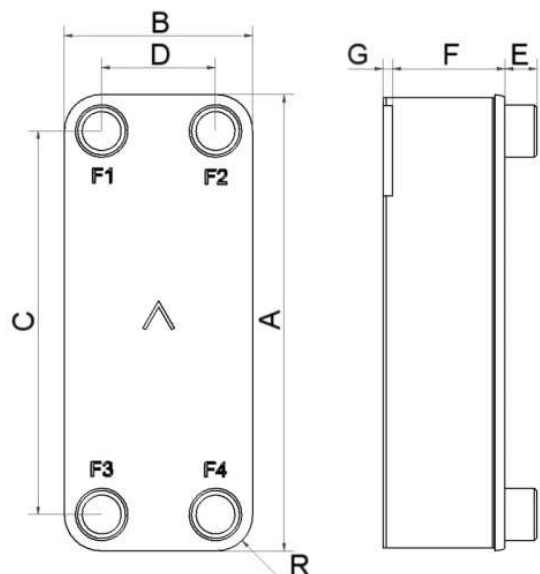

#	MM	IN
A	377	14.84
B	119.50	4.7
C	329	12.95
D	72	2.83
F	4.00+2.01*(NoP)	0.16+0.08*(NoP)
G	6	0.24
R	23.50	0.93
E_1	20	0.79

PED pression / température

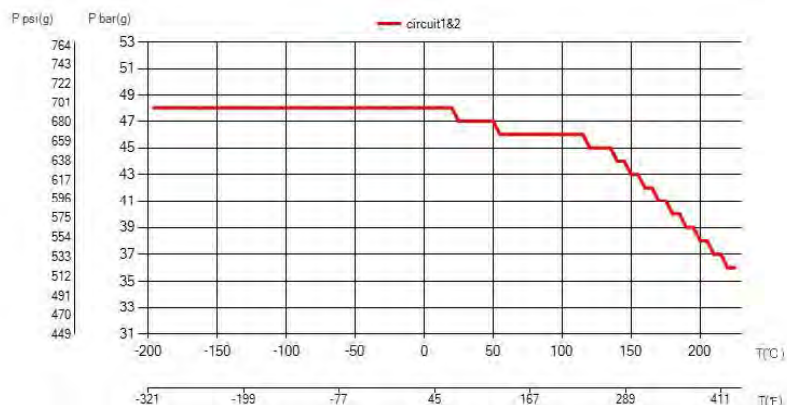

AXINTRA

ÉCHANGEURS THERMIQUES

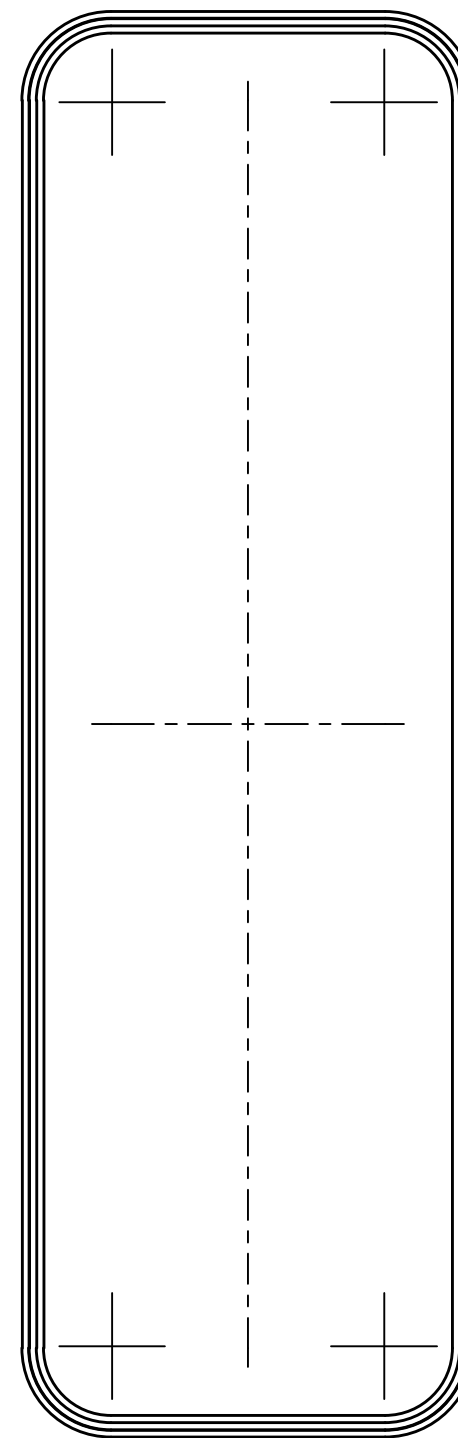
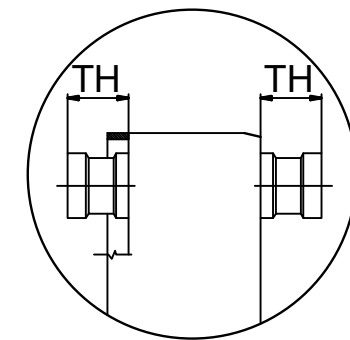
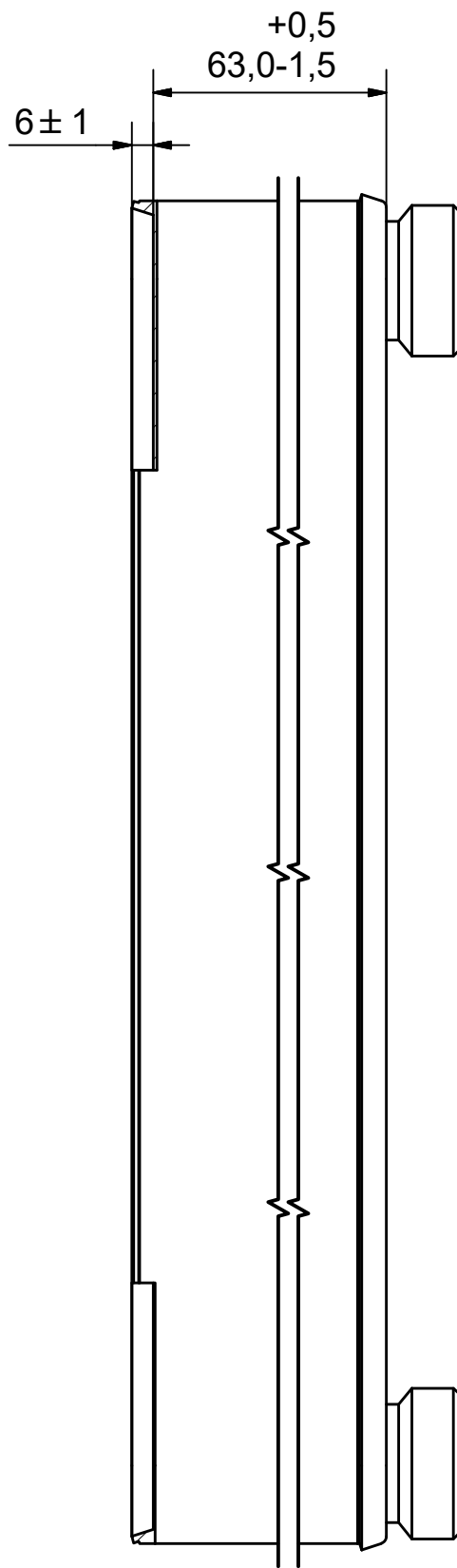
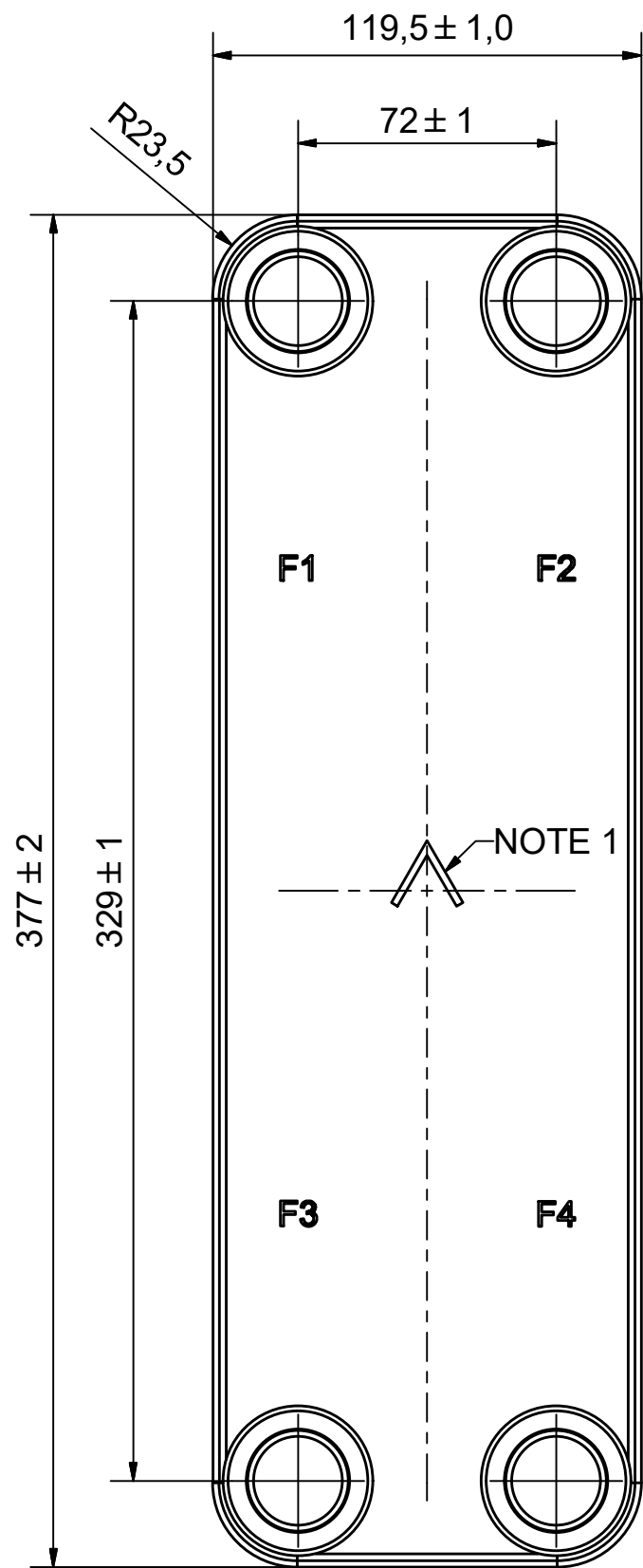



AXINTRA
ÉCHANGEURS THERMIQUES

NOTE 1 ALTERNATE MARKING: STICKER OR STAMP

F4	35086	ISO-G 1 1/4" & SOLDER 28U, TH =	CD001357
F3	35086	ISO-G 1 1/4" & SOLDER 28U, TH =	CD001357
F2	35086	ISO-G 1 1/4" & SOLDER 28U, TH =	CD001357
F1	35086	ISO-G 1 1/4" & SOLDER 28U, TH =	CD001357

Pos	Article No	Title / Denomination, code, material, dimension etc	Drawing No./ref	Pos	Article No	Title / Denomination, code, material, dimension etc	Drawing No./ref
	20,1						

Title				BDW16DWH/1P-SC-M			
 A DOVER COMPANY		Created Date	2017-10-25	Created By	AU		
		Article/Configuration number	15446-030	Drawing number	AU00311727		

Rev No.	Alteration	Date	Checked	Approved
-				PDM

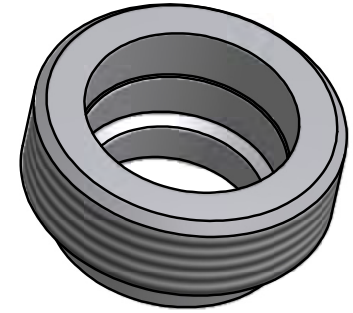
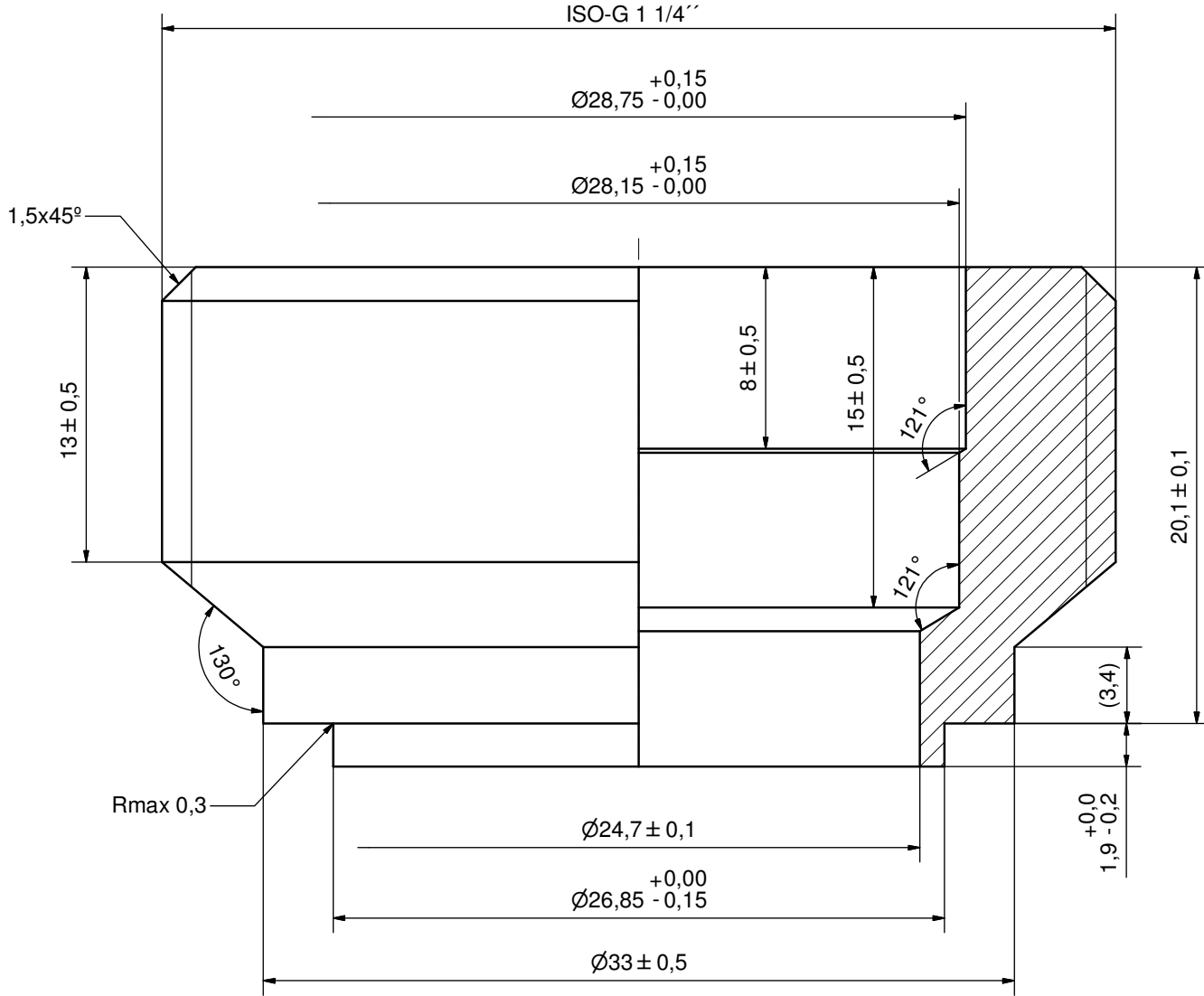

© Company Confidential. Property of SWEP International AB

AXINTRA
ÉCHANGEURS THERMIQUES

Drawn AP	Checked PDM	Approved PDM	Created Date 12/20/2010	General geometrical tolerancing ISO 2768 m	General surface finish R_a 3.2		Scale -
			ISO-G 1 1/4" & SOLDER 28U				
Article number -	DesignType	Drawing number CD001357	Revision -	Sheet 1 (1)			