

B10T

Le B10T offre des solutions d'échange thermique dans un large éventail de capacités. Son adaptation à de nombreuses applications est rapide et simple. Par sa compacité, sa polyvalence, son excellent transfert thermique, ce produit est le choix idéal pour des applications monophasiques et de réfrigération.



Spécifications de base

Nombre de plaques max. (NoP)	140
Débit volumétrique max.	9 m ³ /h (39.63 gpm)
Volume du canal	0.061/0.061 dm ³ (0.0022/0.0022 ft ³)
Matières	Plaques en acier inoxydable 316, brasage cuivre
Poids sans les connexions	1.15+(0.096*NoP) kg 2.54+(0.212*NoP) lb

Les dimensions standard

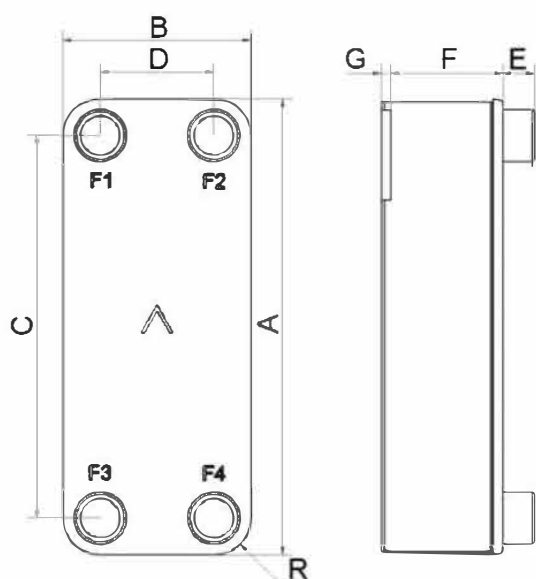

#	MM	IN
A	289	11.38
B	119	4.69
C	243	9.57
D	72	2.83
F	4.00+2.24*(NoP)	0.16+0.09*(NoP)
G	6	0.24
R	22	0.87
E_1	20	0.79

PED pression / température

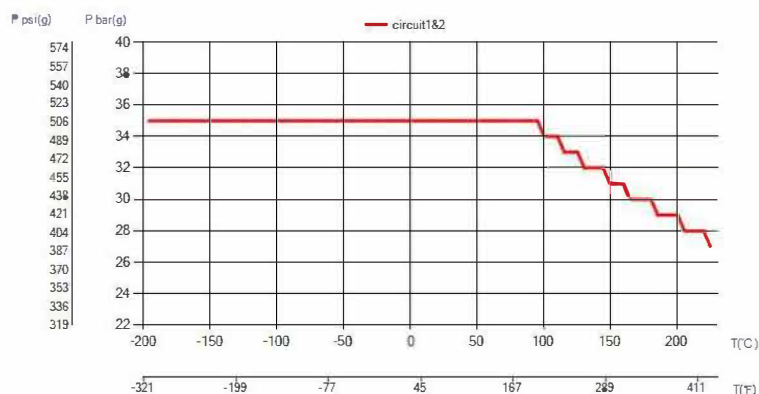

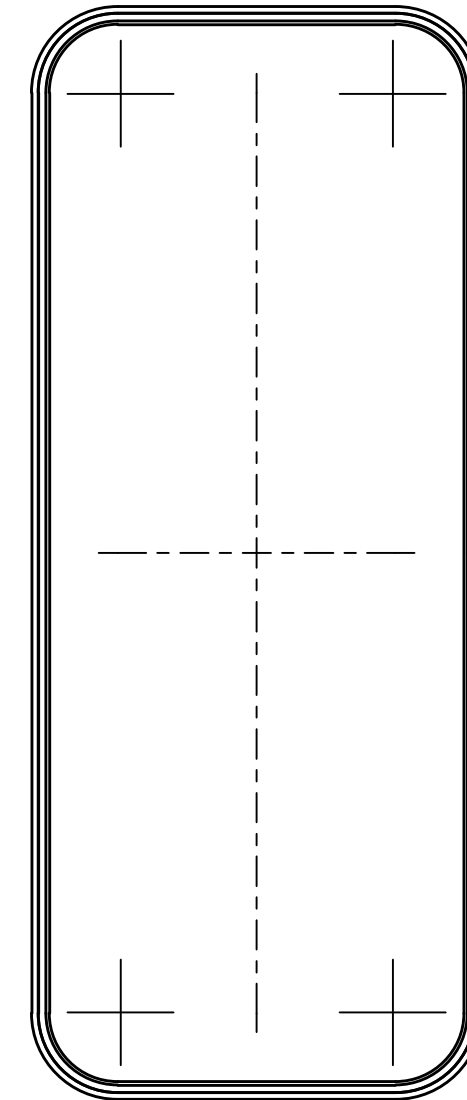
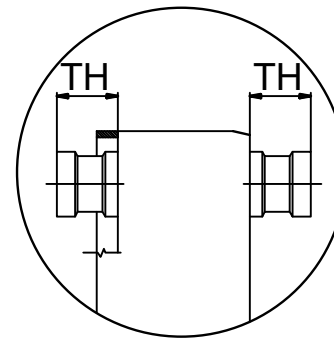
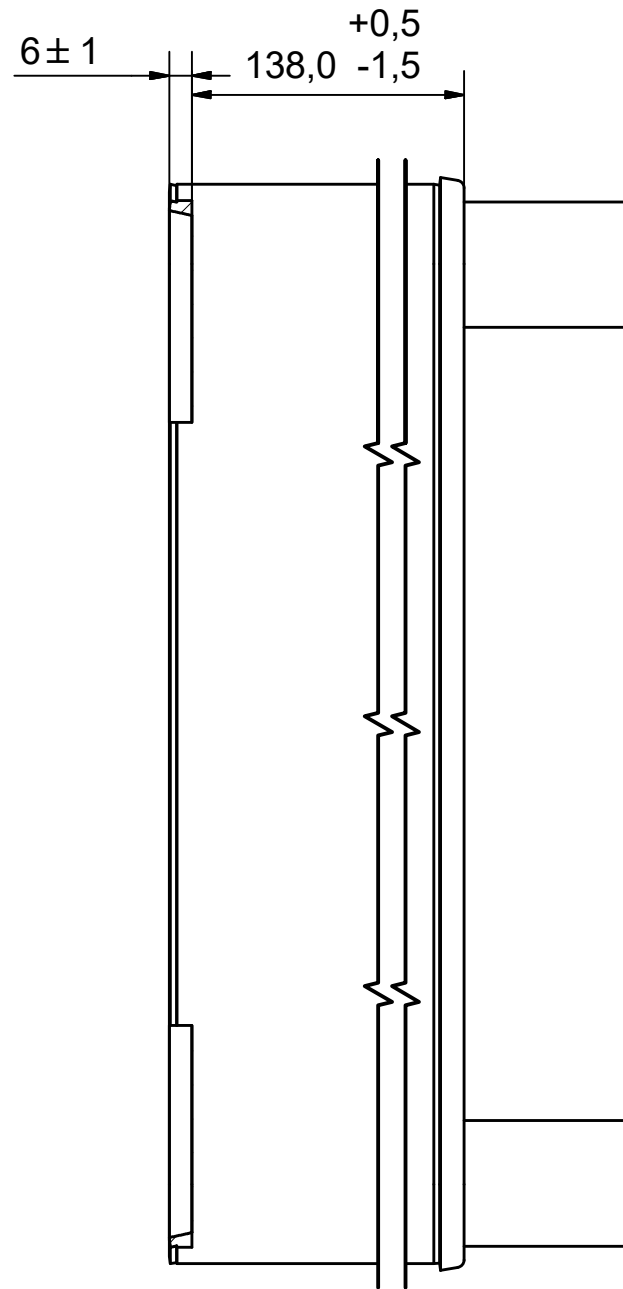
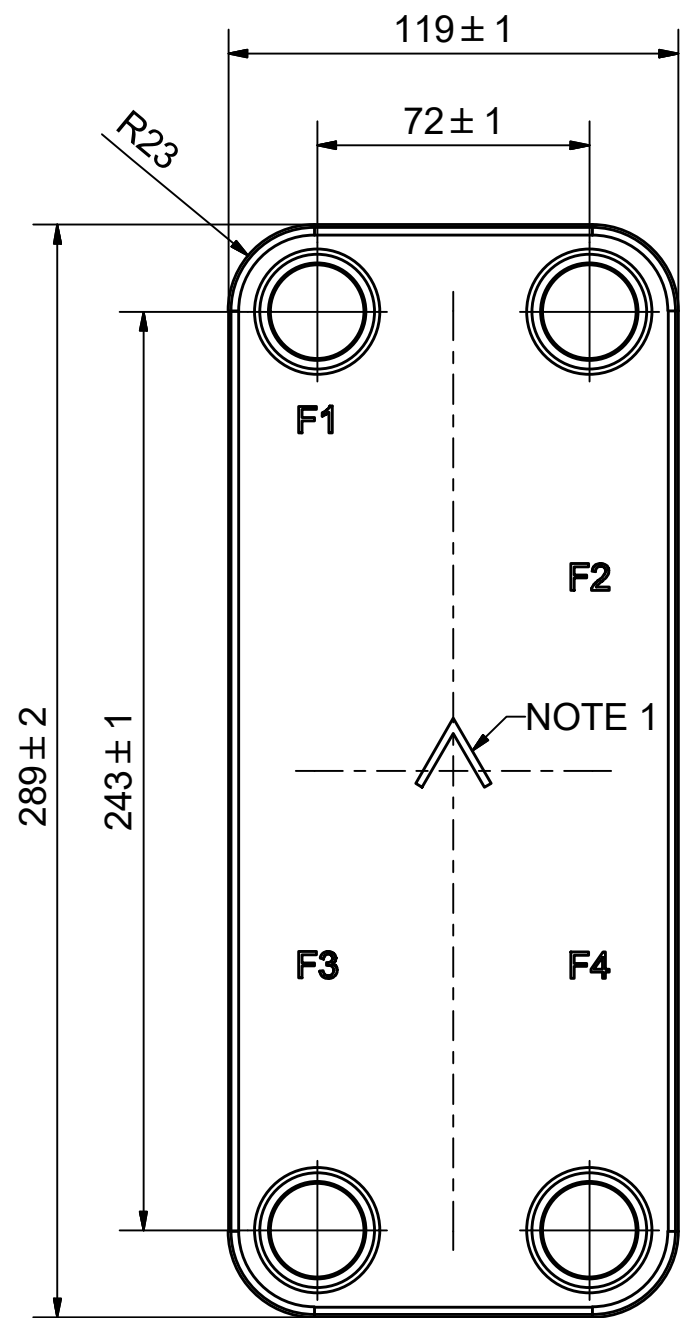

AXINTRA

ÉCHANGEURS THERMIQUES

F4	45051	ISO-G 1" A, TH = 45,1	CD000036
F3	45051	ISO-G 1" A, TH = 45,1	CD000036
F2	45051	ISO-G 1" A, TH = 45,1	CD000036
F1	45051	ISO-G 1" A, TH = 45,1	CD000036

NOTE 1 ALTERNATE MARKING: STICKER OR STAMP

Pos	Article No	Title / Denomination, code, material, dimension etc	Drawing No./ref	Pos	Article No	Title / Denomination, code, material, dimension etc	Drawing No./ref
-----	------------	---	-----------------	-----	------------	---	-----------------

Title		B10TH/1P-SC-S	
 A DOVER COMPANY		Created Date	2019-05-28
		Created By	AU
Article/Configuration number		13830-060	
Drawing number		AU00493852	

SWEP MANUFACTURING

Rev No.	Alteration	Date	Checked	Approved
14	CHANGED TOLERANCE OF THREAD	2006/12/11	THE	PDM

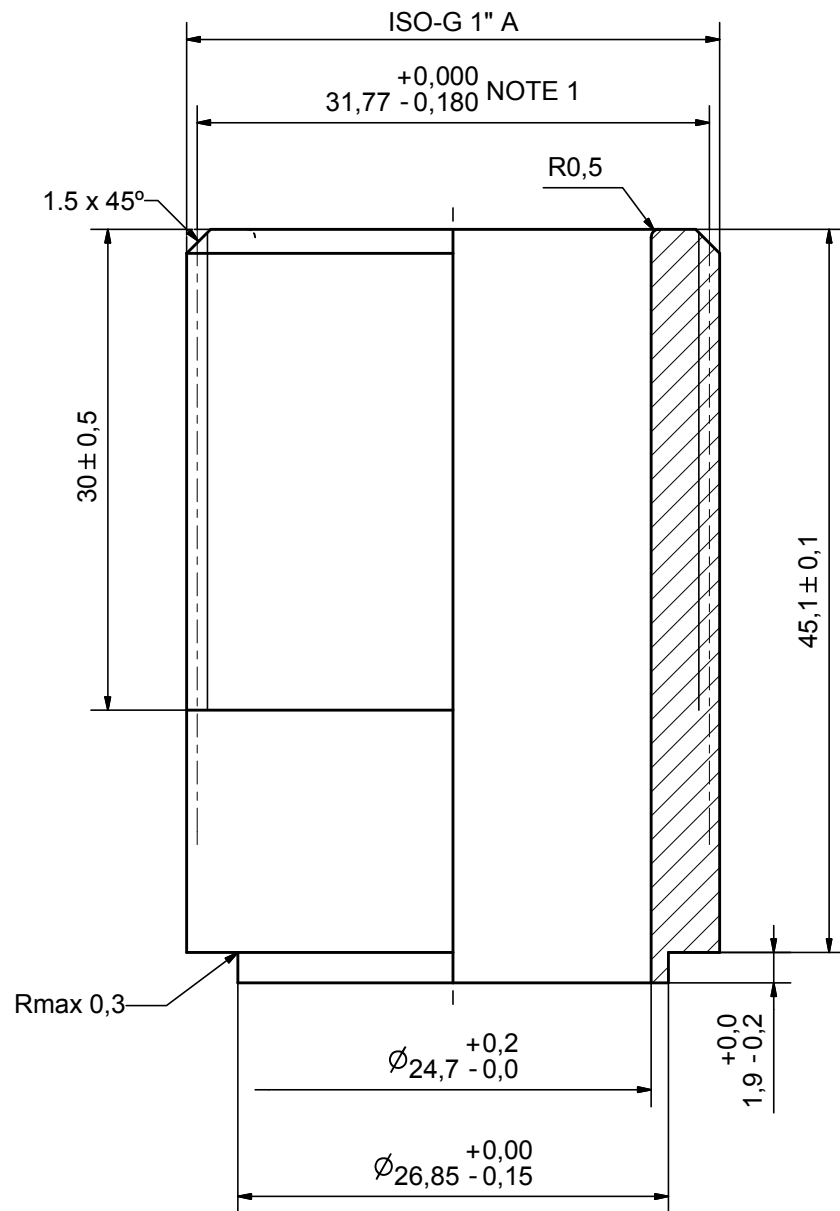

NOTE 1: ADDITIONAL REQUIREMENT ON ISO 228/1 THREAD
PERMISSIBLE TOLERANCE ON PITCH DIAMETER

ACCORDING TO MQS
MATERIAL

Drawn	Checked	Approved	Created Date	General geometrical tolerancing ISO 2768	General surface finish R_a	Scale
EG	HR	BOS	1990/09/08	m	3.2	3:1
Title			ISO-G 1" A			
Article number		Drawing number		Revision	Sheet	
-		CD000036		14	1 (2)	