

B12

Avec ses larges ports, le B12 apporte des solutions de transfert thermique adaptées aux débits importants. Il est disponible avec différents agencements de plaques pour répondre aux besoins d'une gamme étendue de viscosités et densités des fluides. Le B12 est un excellent choix pour les applications exigeantes comme la vapeur et les dessiccateurs d'air. Il peut servir de désurchauffeur dans un système de climatisation et de CO2 sous refroidisseur gaz pour système de réfrigération.



Spécifications de base

Nombre de plaques max. (NoP)	140
Débit volumétrique max.	16,9 m ³ /h (39.63 gpm)
Volume du canal	0.063/0.063 dm ³ (0.0022/0.0022 ft ³)
Matières	Plaques en acier inoxydable 316, brasage cuivre
Poids sans les connexions	1.12+(0.12*NoP) kg 2.47+(0.265*NoP) lb

Les dimensions standard

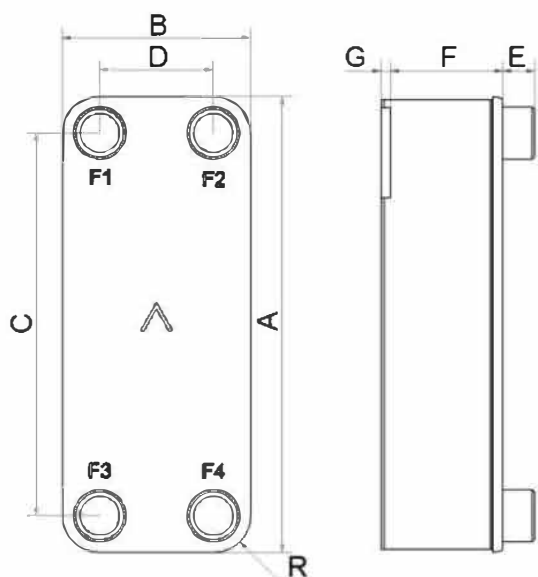

#	MM	N
A	287	11.3
B	117	4.61
C	234	9.21
D	63	2.48
F	4.40+2.34*(NoP)	0.17+0.09*(NoP)
G	6	0.24
R	22	0.87
E_1	27	1.06

PED pression / température

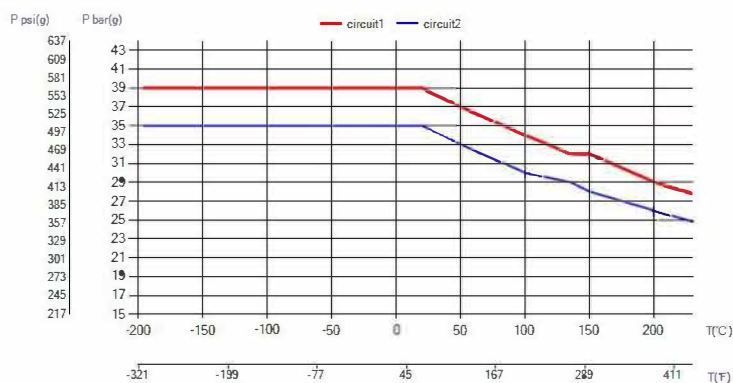

AXINTRA

ÉCHANGEURS THERMIQUES

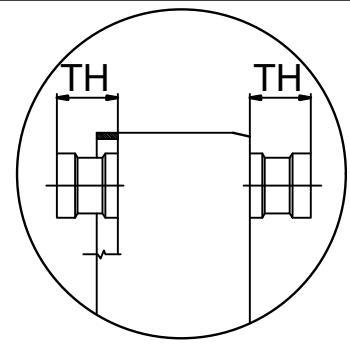
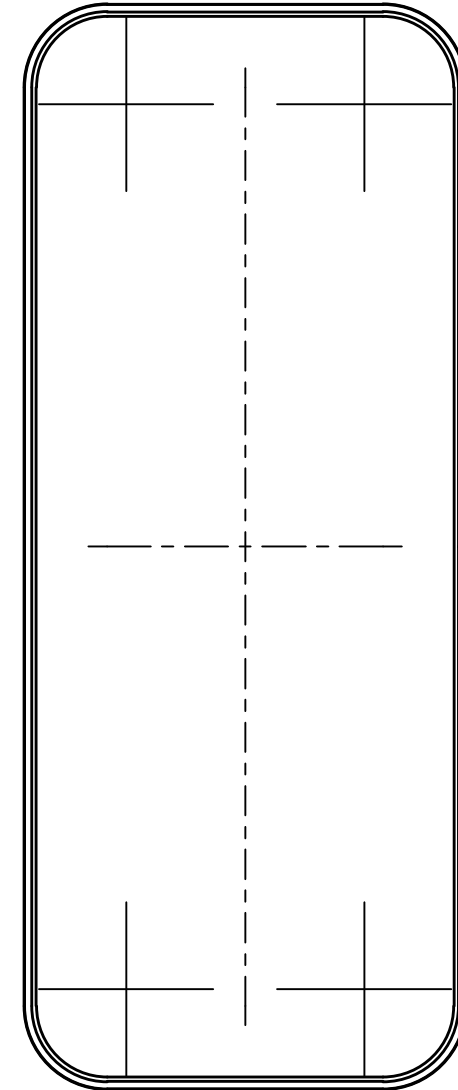
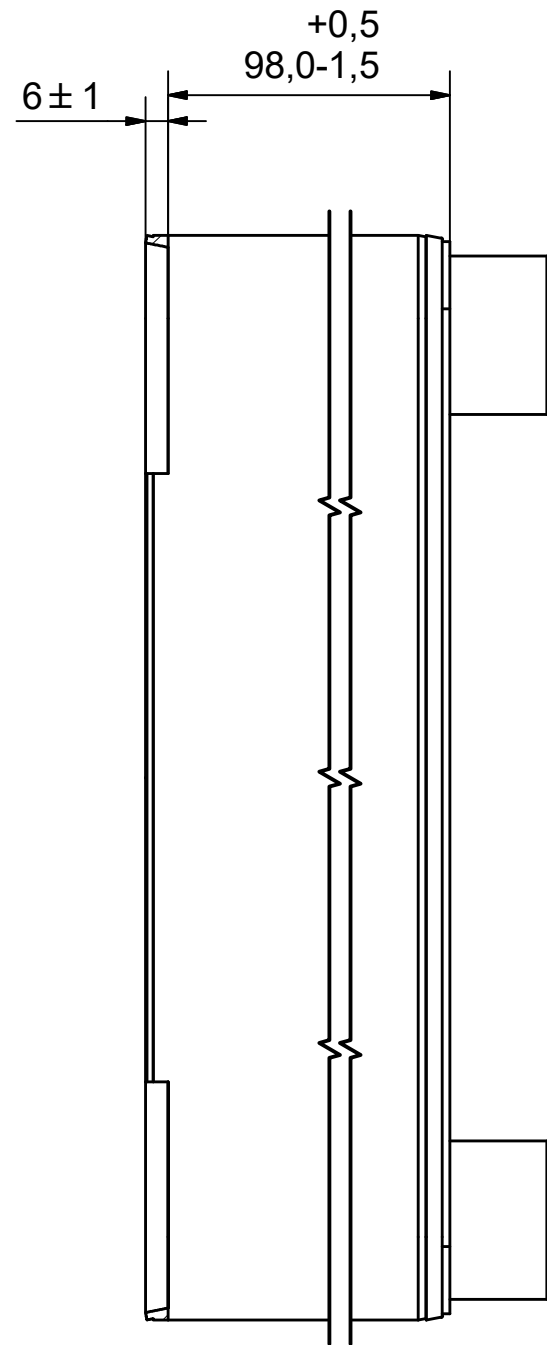
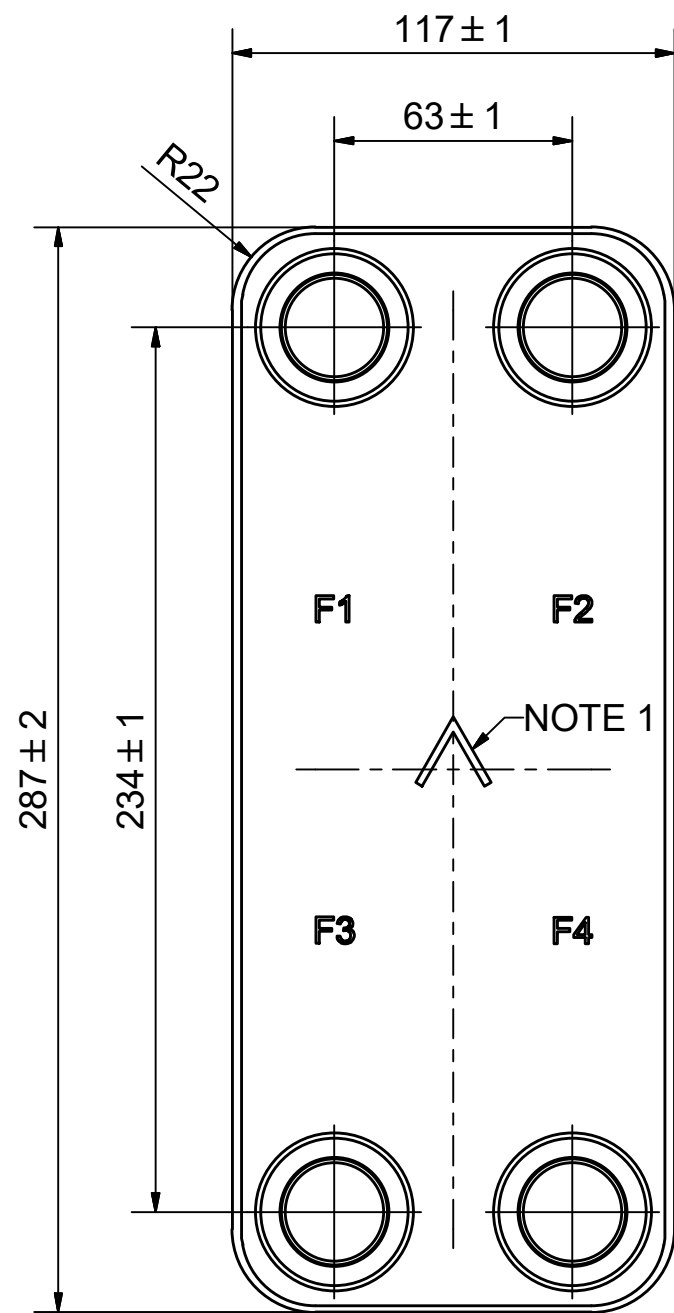

AXINTRA
ÉCHANGEURS THERMIQUES

NOTE 1 ALTERNATE MARKING: STICKER OR STAMP

F4	32567	ISO-G 1 1/4" A & SOLDER 28U, TH = 27,1	CD000807
F3	32567	ISO-G 1 1/4" A & SOLDER 28U, TH = 27,1	CD000807
F2	32567	ISO-G 1 1/4" A & SOLDER 28U, TH = 27,1	CD000807
F1	32567	ISO-G 1 1/4" A & SOLDER 28U, TH = 27,1	CD000807

Pos	Article No	Title / Denomination, code, material, dimension etc	Drawing No./ref	Pos	Article No	Title / Denomination, code, material, dimension etc	Drawing No./ref
-----	------------	---	-----------------	-----	------------	---	-----------------

Title		B12L/1P-SC-S	
 A DOVER COMPANY		Created Date	2018-06-21
		Created By	AU
		Article/Configuration number	14523-040
		Drawing number	AU00389557

Rev No.	Alteration	Date	Checked	Approved
1	CHANGED DENOMINATION	2007/05/28	ANL	PDM

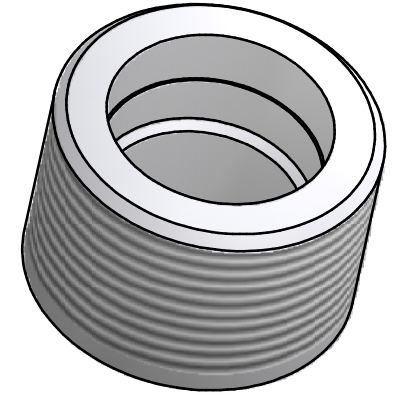
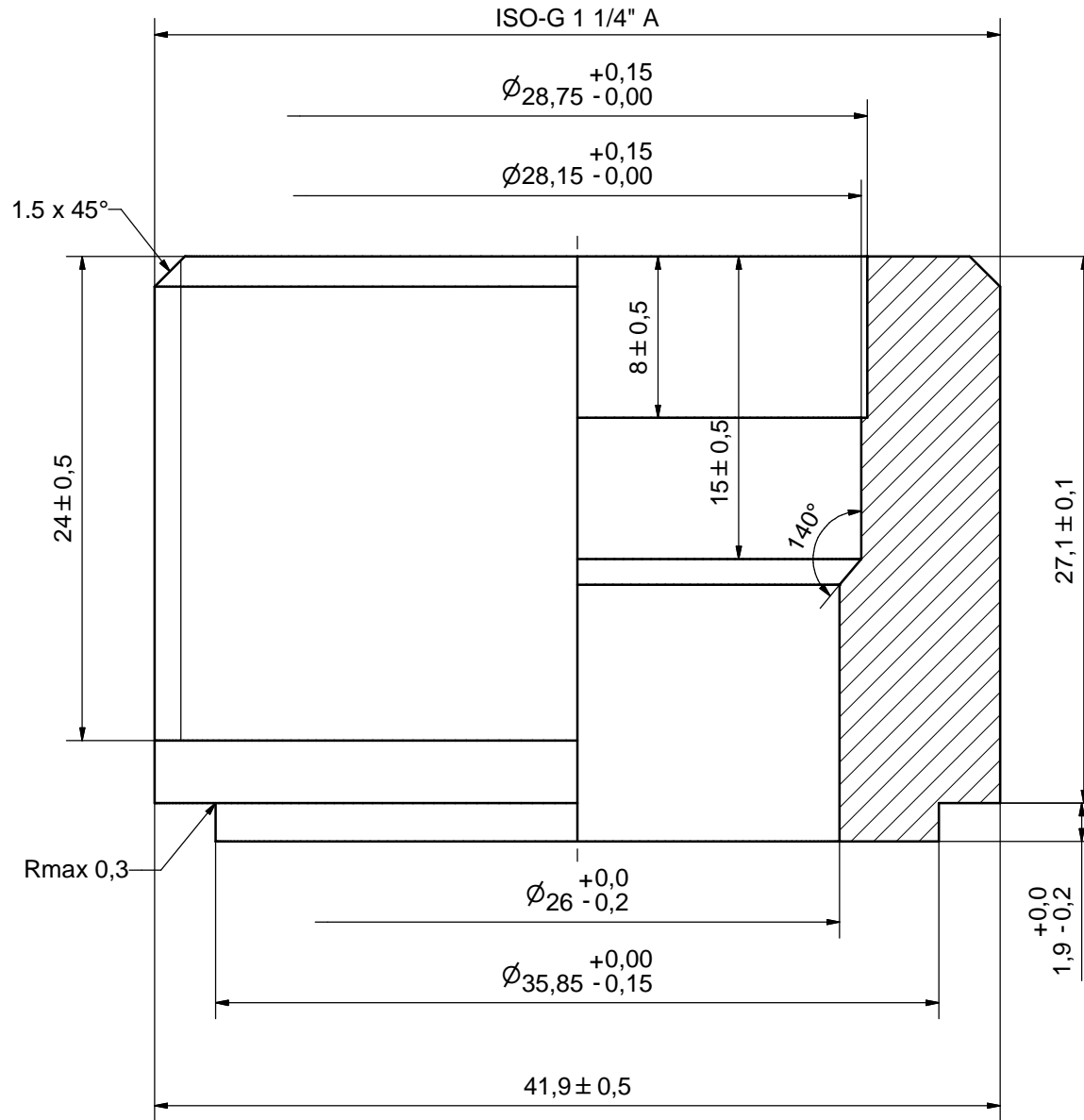

ACCORDING TO MQS
MATERIAL

Drawn	Checked	Approved	Created Date	General geometrical tolerancing ISO 2768	General surface finish R_a	Scale
THE	PDM	PDM	2006/05/09	m	3.2	4:1
Title				ISO-G 1 1/4" A & SOLDER 28U		
Article number		Drawing number		Revision	Sheet	
-		CD000807		1	1 (1)	