

V120T

Le V120T est un évaporateur qui offre une efficacité élevée avec de nombreux réfrigérants. Il combine un format compact et un agencement de plaques spécialement développé pour créer un échangeur thermique extrêmement efficace. Le V120T est le choix idéal pour les chillers, les pompes à chaleur et les économiseurs.



Spécifications de base

Nombre de plaques max. (NoP)	250
Débit volumétrique max.	27,4 m³/h (17.61 gpm)
Volume du canal	0.241/0.241 dm³ (0.0085/0.0085 ft³)
Matières	Plaques en acier inoxydable 316, brasage cuivre
Poids sans les connexions	8.33+(0.424*NoP) kg 18.36+(0.935*NoP) lb

Les dimensions standard

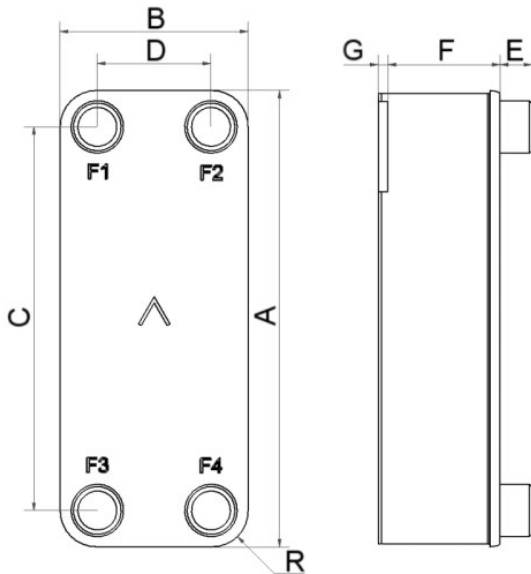

#	MM	IN
A	525	20.67
B	243	9.57
C	456	17.95
D	174	6.85
F	10.00+2.29*(NoP)	0.39+0.09*(NoP)
G	4	0.16
R	35	1.38
E_1	27	1.06

PED pression / température

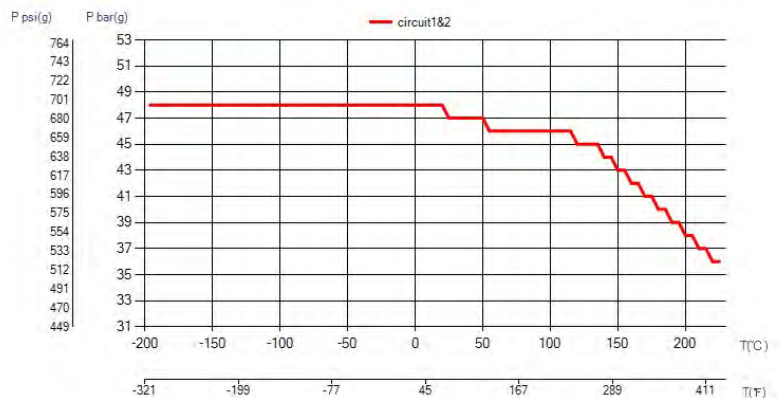

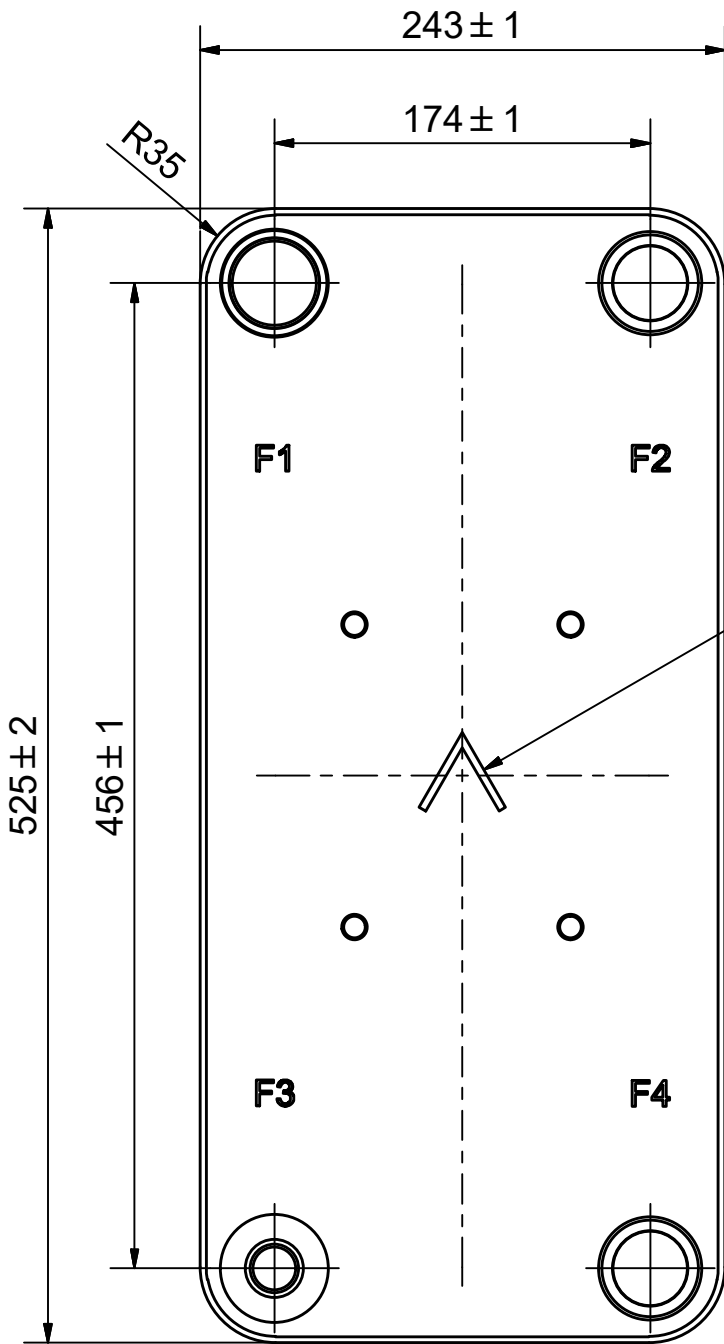

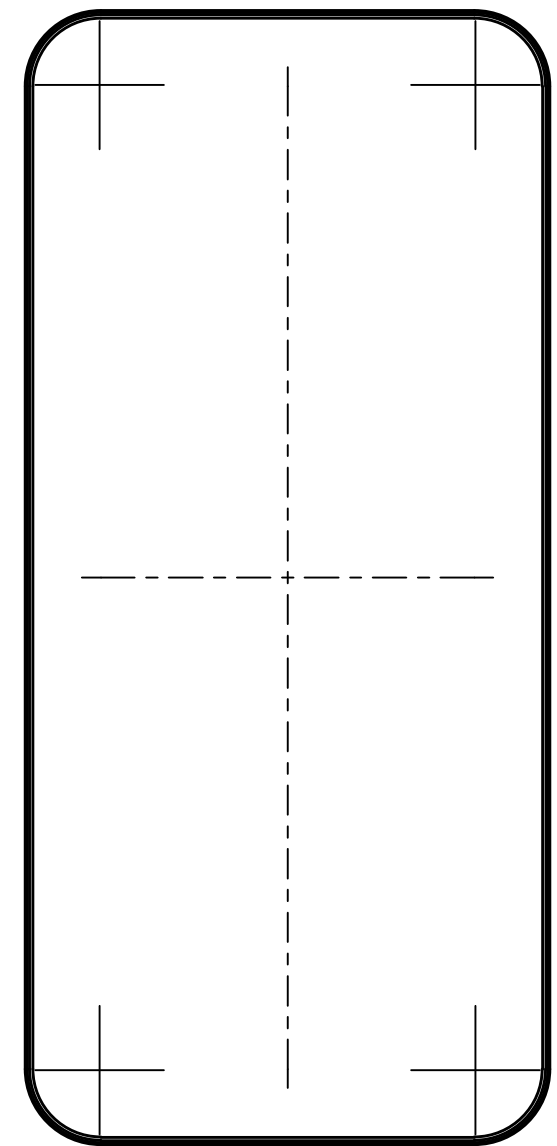
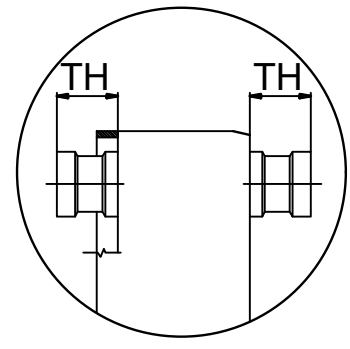
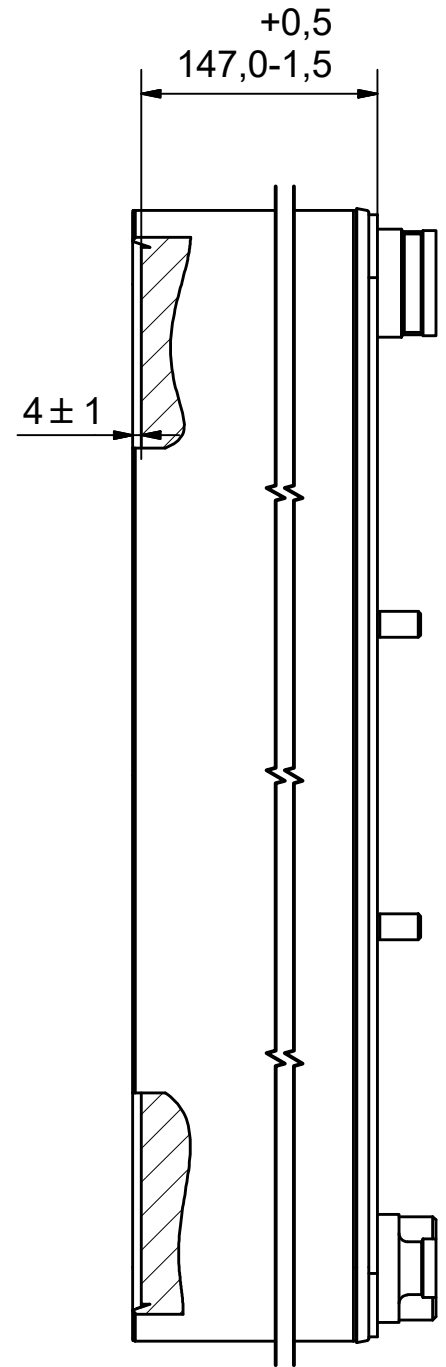

NOTE 1



AXINTRA
ÉCHANGEURS THERMIQUES

NOTE 1 ALTERNATE MARKING: STICKER OR STAMP

F4	32836	ISO-G 1 1/2" & SOLDER 35,1, TH =	CD000860
F3	45475	SOLDER 22U, TH = 27,1	CD000017
F2	32836	ISO-G 1 1/2" & SOLDER 35,1, TH =	CD000860
F1	45083	SOLDER 42U, TH = 27,1	CD000100
F	21118	B120T/50 BOLT LOC F 4x C140x100	CG450024

Title		V120TH/1P-SC-M	
 A DOVER COMPANY	Created Date	Created By	
	2018-06-25	AU	
	Article/Configuration number	Drawing number	
	14172-060	AU00390820	

Pos	Article No	Title / Denomination, code, material, dimension etc	Drawing No./ref	Pos	Article No	Title / Denomination, code, material, dimension etc	Drawing No./ref
-----	------------	---	-----------------	-----	------------	---	-----------------

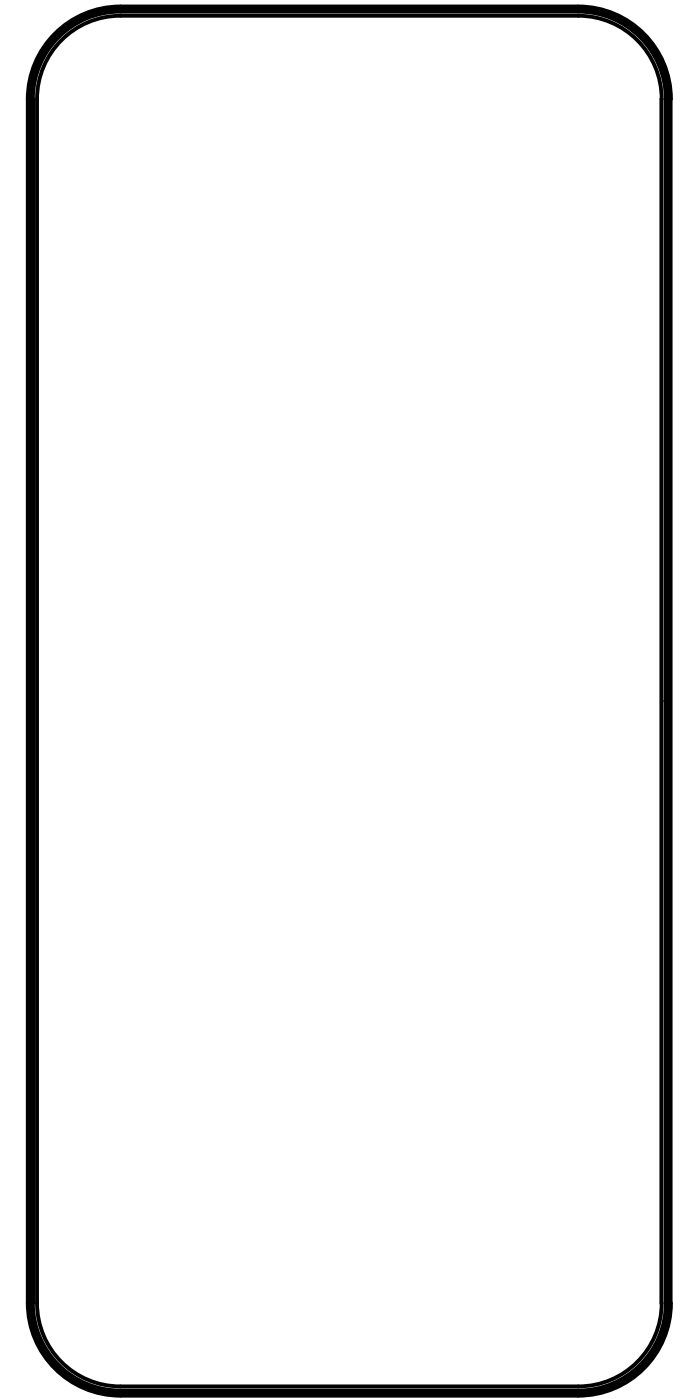
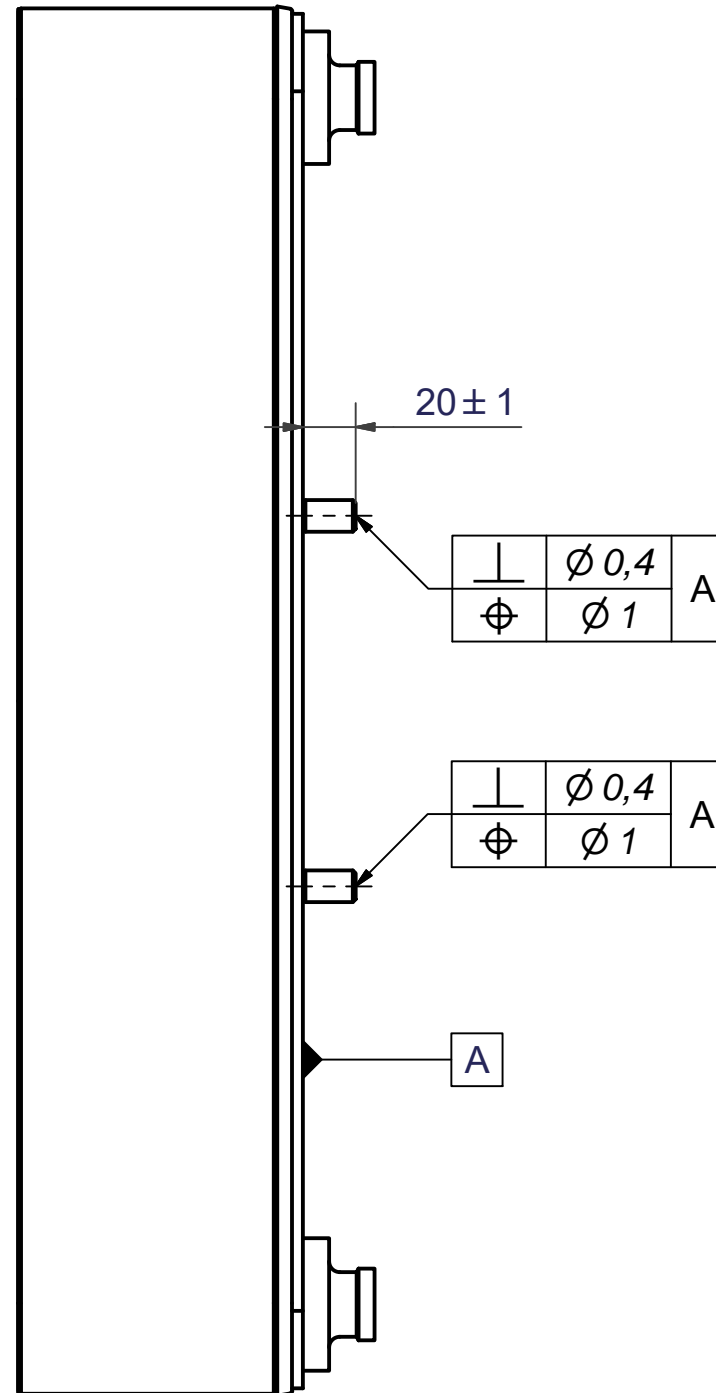
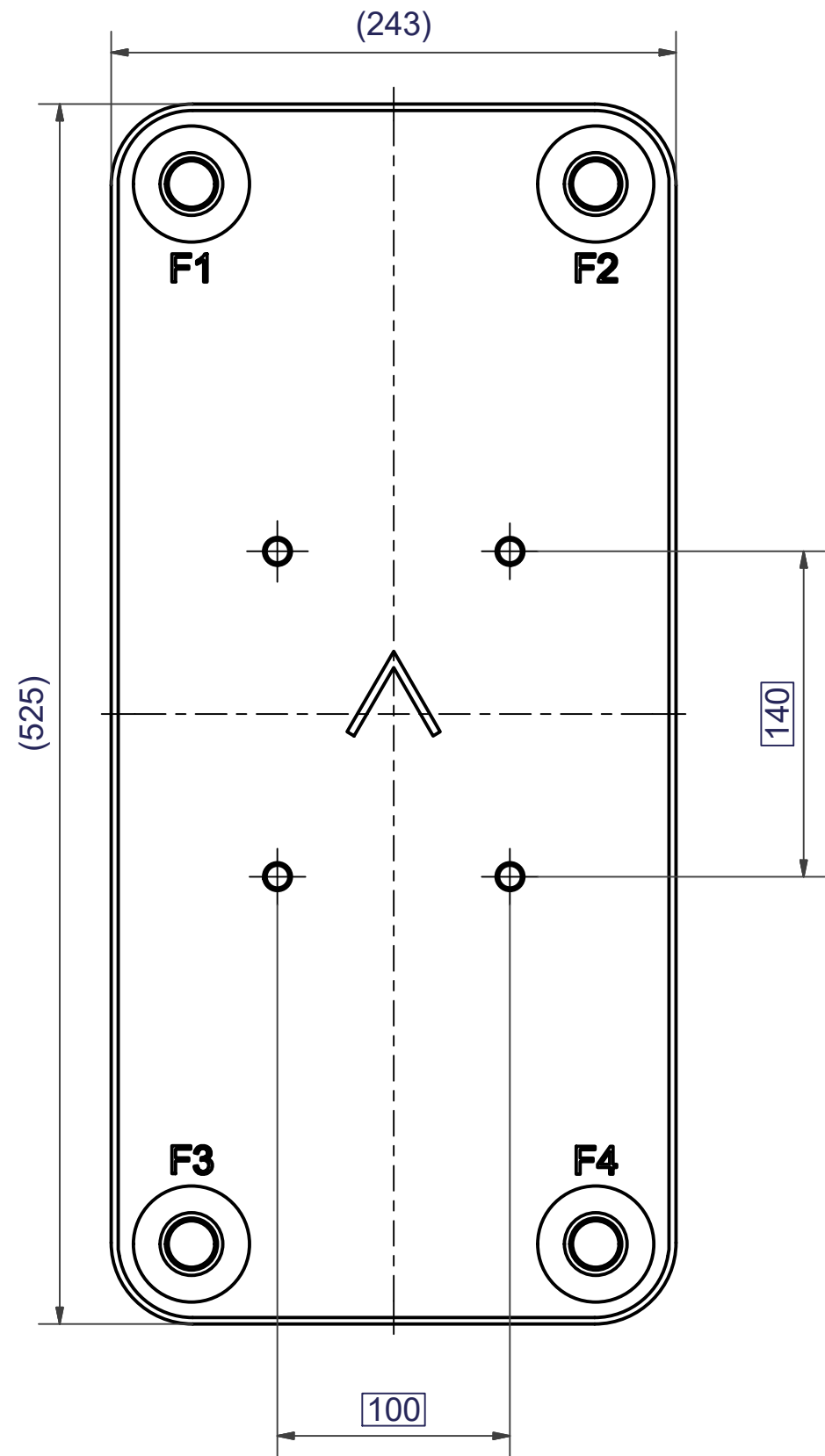

1	4	STUD BOLT M12x20 ART. NO. 45095	M12x20
IT	QTY	DESCRIPTION	Drawing No./Ref
lathe	PDM	PDM	2004-10-12
		General geometrical tolerancing ISO 2768: m	General surface finish R _a : 3.2
		Scale: 1:1	
		B120T/50 BOLT LOC F 4x C140x100	
Article number		Drawing number	Revision
21118		CG450024	00
		Sheet	1 (1)

Rev No.	Alteration	Date	Checked	Approved
12	DEBURRING INFO ADDED	2009/03/10	TL	PDM

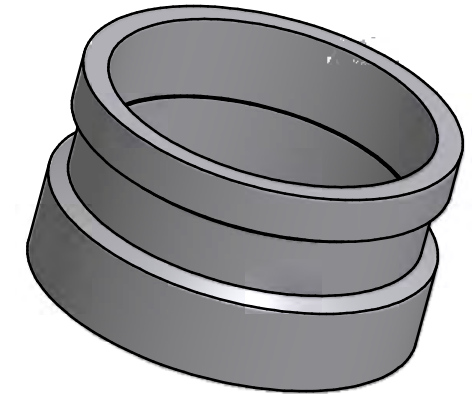
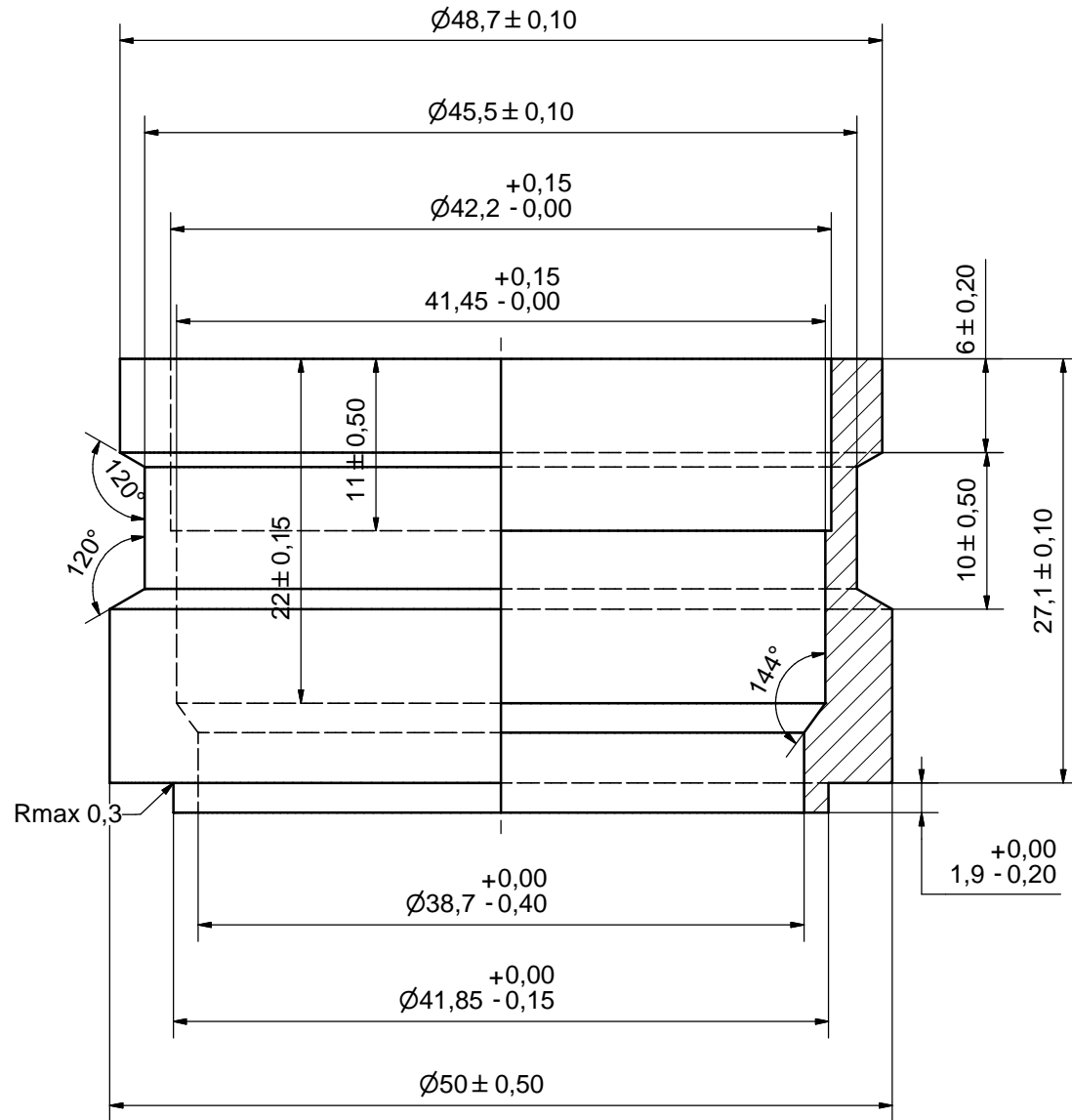

SHARP EDGES DEBURRED MAX 0,4

ACCORDING TO MQS
MATERIAL

Drawn	SA	Checked	TP	Approved	VP	Created Date	1990-09-08	General geometrical tolerancing ISO 2768	m	General surface finish R_a	3.2	Scale	-					
Title												SOLDER 42U						
Article number												-	Drawing number	CD000100	Revision	12	Sheet	1 (1)

Rev No.	Alteration	Date	Checked	Approved
1	DEBURRING INFO ADDED	2009/03/11	TL	PDM

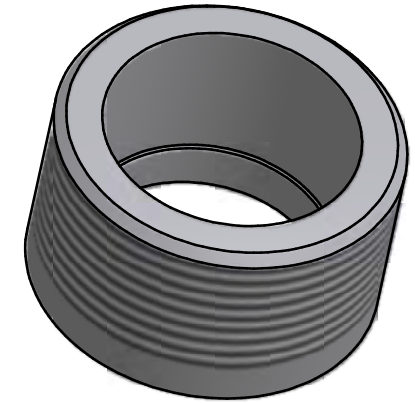
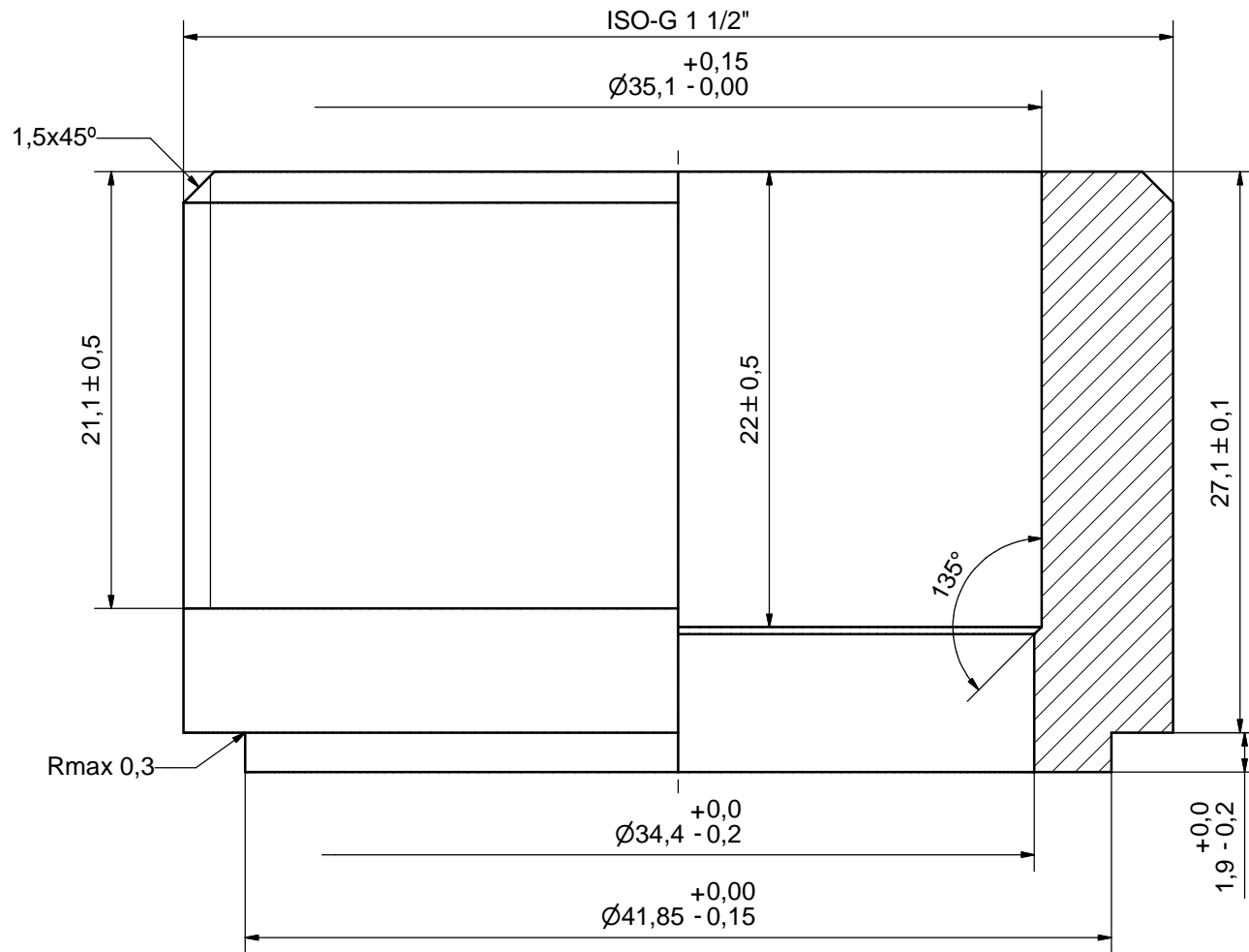

SHARP EDGES DEBURRED MAX 0,4

ACCORDING TO MQS
MATERIAL

Drawn ANL	Checked PDM	Approved PDM	Created Date 2007-04-25	General geometrical tolerancing ISO 2768 m	General surface finish R_a 3.2		Scale -
			Title ISO-G 1 1/2" & SOLDER 35,1				
Article number -		Drawing number CD000860		Revision 1		Sheet 1 (1)	