

B5T

Le B5T permet d'obtenir un échange thermique efficace dans des applications à faible débit qui exigent un espace restreint. Facile à installer et utiliser, ce produit est compact et polyvalent. C'est donc un choix bien adapté aux refroidisseurs d'eau ou d'huile de petite taille.



Spécifications de base

Nombre de plaques max. (NoP)	60
Débit volumétrique max.	4 m ³ /h (17.61 gpm)
Volume du canal	0.024/0.024 dm ³ (0.0008/0.0008 ft ³)
Matières	Plaques en acier inoxydable 316, brasage cuivre
Poids sans les connexions	0.50+(0.044*NoP) kg 1.09+(0.097*NoP) lb

Les dimensions standard

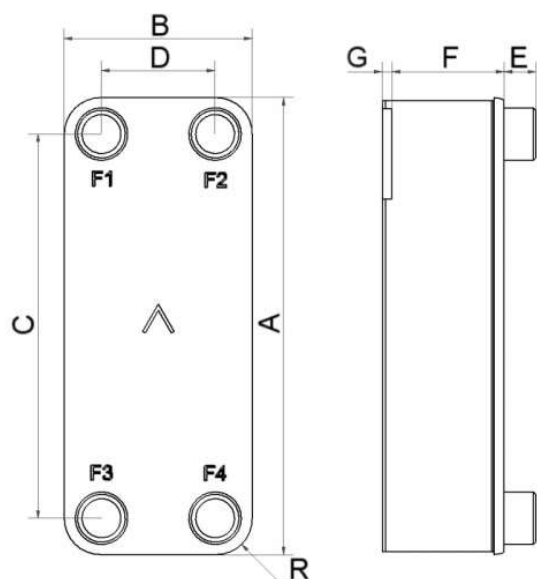

#	MM	IN
A	193	7.6
B	76	2.99
C	154	6.06
D	40	1.57
F	4.00+2.24*(NoP)	0.16+0.09*(NoP)
G	6.20	0.24
R	18	0.71
E_1	20	0.79

PED pression / température

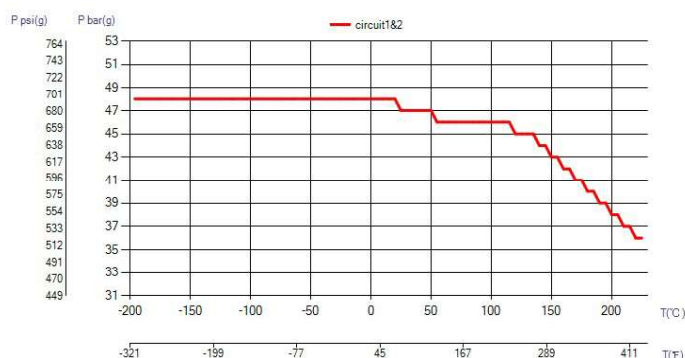

AXINTRA

ÉCHANGEURS THERMIQUES

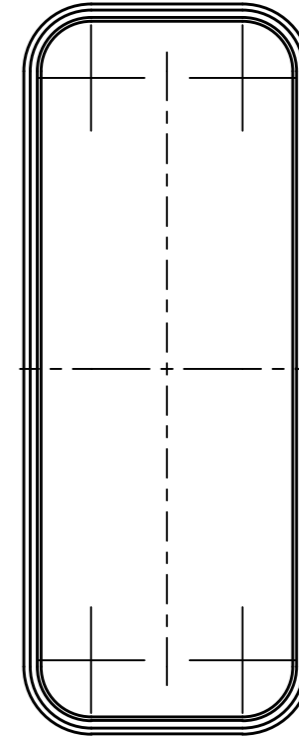
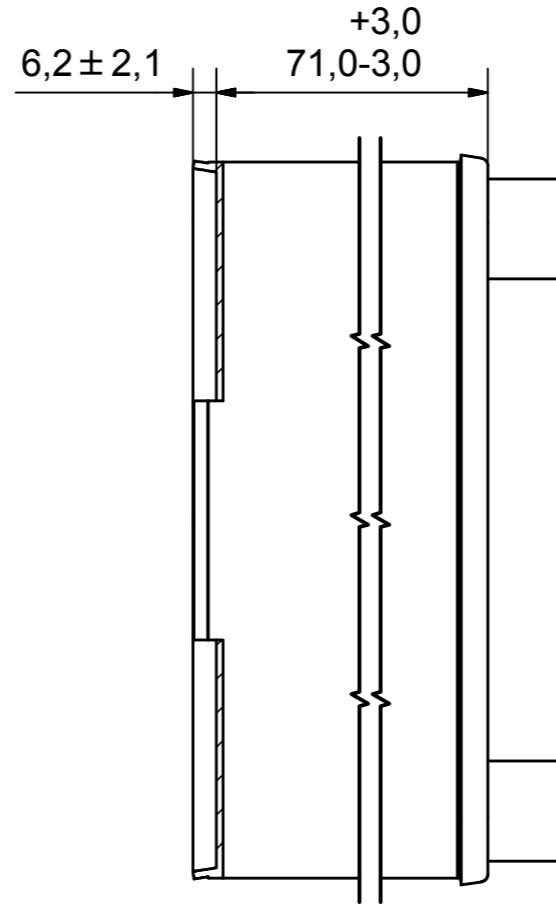
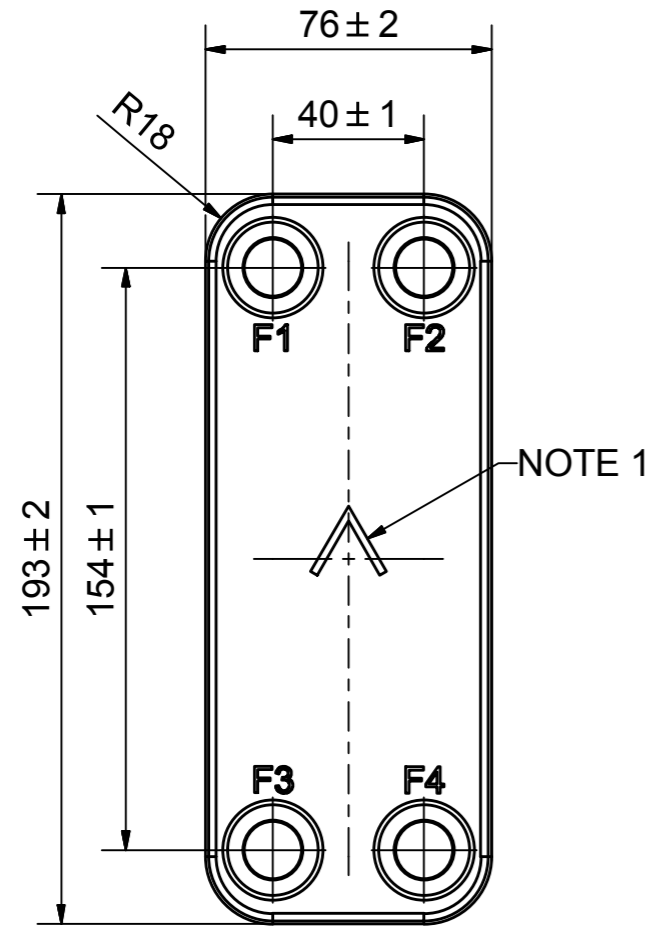
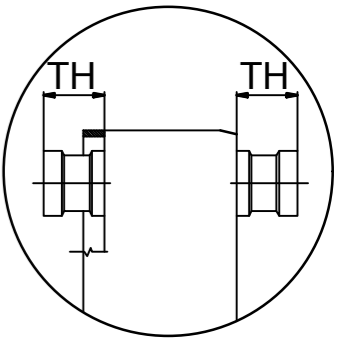



NOTE 1 ALTERNATE MARKING: STICKER OR STAMP

AXINTRA
ÉCHANGEURS THERMIQUES

F4	32835	ISO-G 3/4" & SOLDER 16, TH = 20,1	CD000859
F3	32835	ISO-G 3/4" & SOLDER 16, TH = 20,1	CD000859
F2	32835	ISO-G 3/4" & SOLDER 16, TH = 20,1	CD000859
F1	32835	ISO-G 3/4" & SOLDER 16, TH = 20,1	CD000859

Pos	Article No	Title / Denomination, code, material, dimension etc	Drawing No./ref	Pos	Article No	Title / Denomination, code, material, dimension etc	Drawing No./ref
-----	------------	---	-----------------	-----	------------	---	-----------------

Title		B5TH/1P-SC-M	
 A DOVER COMPANY	Created Date	2017-06-15	Created By
	Article/Configuration number	14626-030	Drawing number
		AU	
			
		AU00278026	

Rev No.	Alteration	Date	Checked	Approved
1	CHANGED INNER DIAMETER	2007/09/17	ANL	PDM

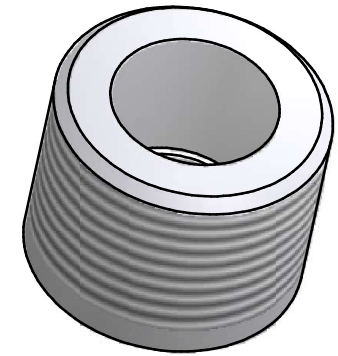
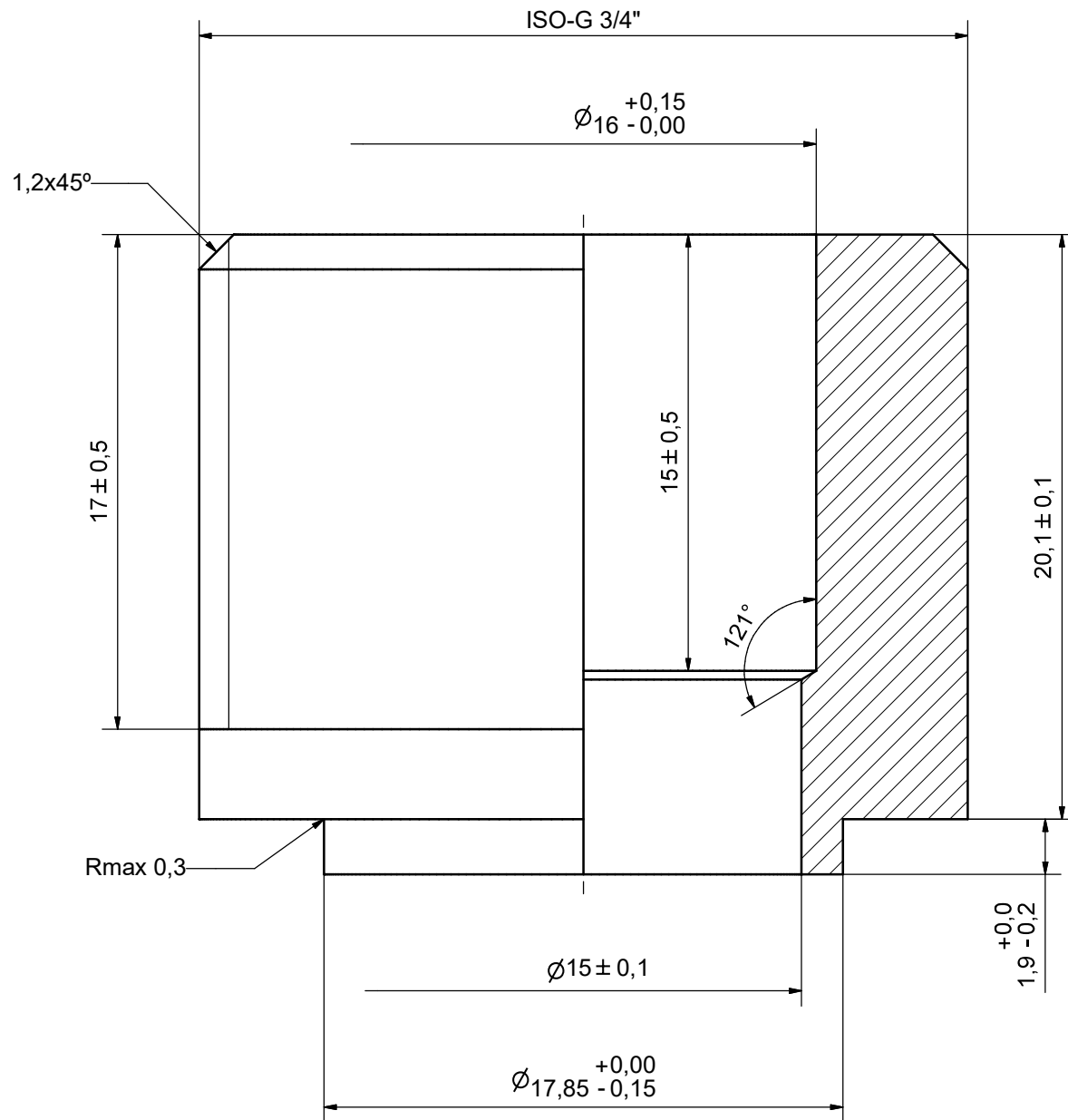

© Company Confidential, Property of SWEP International AB

AXINTRA
ÉCHANGEURS THERMIQUES

ACCORDING TO MQS
MATERIAL

Drawn	Checked	Approved	Created Date	General geometrical tolerancing ISO 2768	General surface finish R_a	Scale
ANL	PDM	PDM	2007/04/25	m	3.2	5:1
			Title ISO-G 3/4" & SOLDER 16			
Article number -		Drawing number CD000859		Revision 1		Sheet 1 (1)