

# B5T

Le B5T permet d'obtenir un échange thermique efficace dans des applications à faible débit qui exigent un espace restreint. Facile à installer et utiliser, ce produit est compact et polyvalent. C'est donc un choix bien adapté aux refroidisseurs d'eau ou d'huile de petite taille.

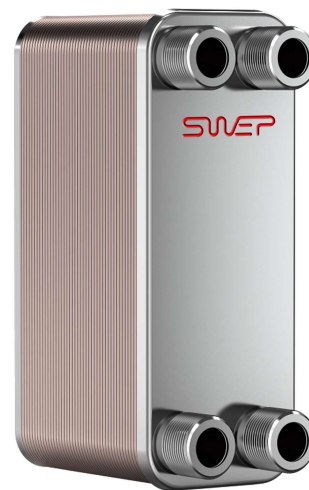

## Spécifications de base

Nombre de plaques max. (NoP)	60
Débit volumétrique max.	4 m <sup>3</sup> /h (17.61 gpm)
Volume du canal	0.024/0.024 dm <sup>3</sup> (0.0008/0.0008 ft <sup>3</sup> )
Matières	Plaques en acier inoxydable 316, brasage cuivre
Poids sans les connexions	0.50+(0.044*NoP) kg 1.09+(0.097*NoP) lb

## Les dimensions standard

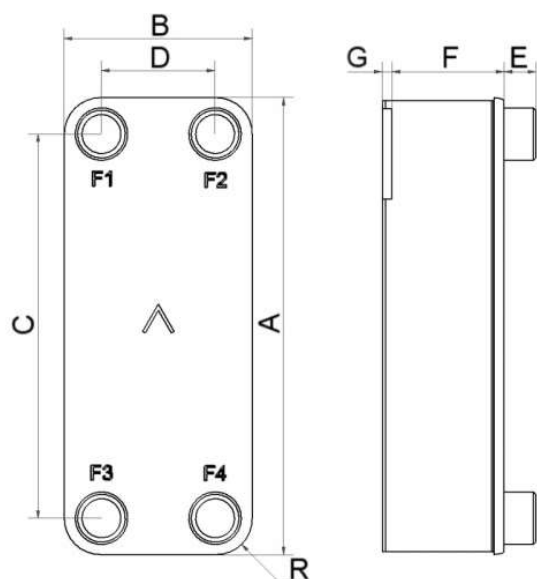

#	MM	IN
A	193	7.6
B	76	2.99
C	154	6.06
D	40	1.57
F	4.00+2.24*(NoP)	0.16+0.09*(NoP)
G	6.20	0.24
R	18	0.71
E_1	20	0.79

## PED pression / température

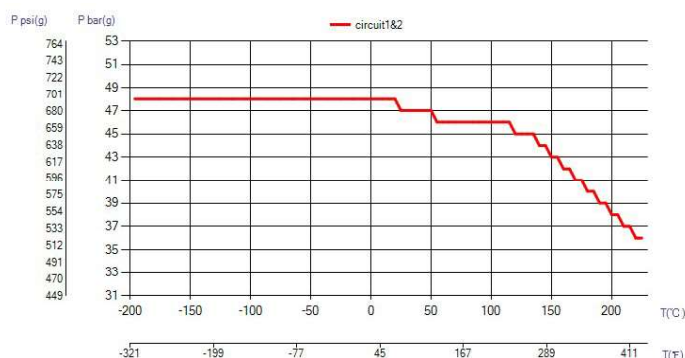

ÉCHANGEURS THERMIQUES

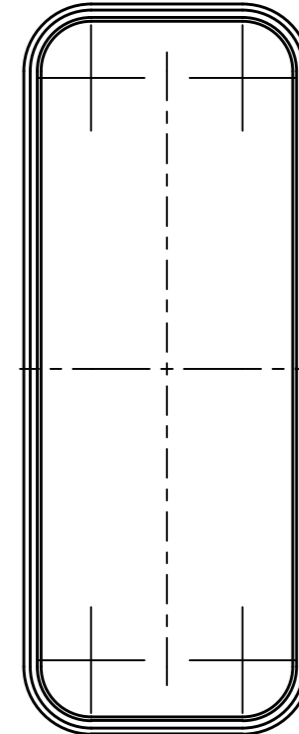
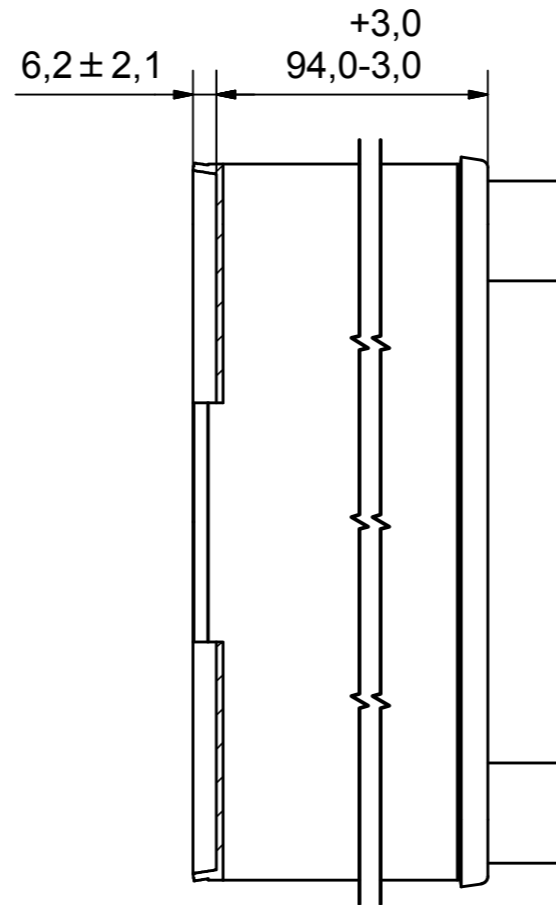
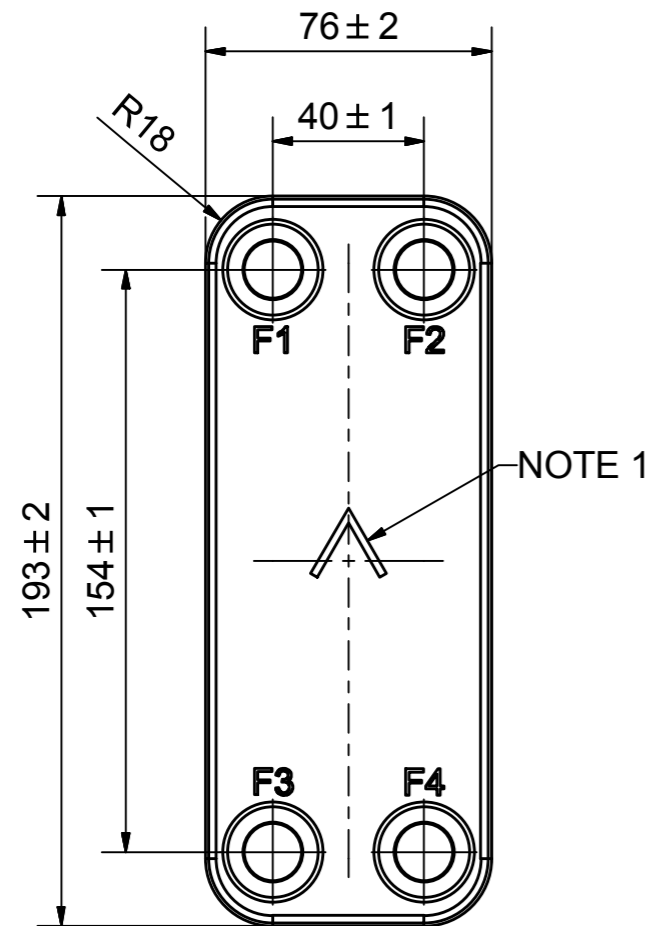
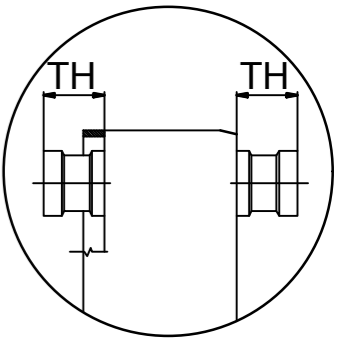

NOTE 1 ALTERNATE MARKING: STICKER OR STAMP



ÉCHANGEURS THERMIQUES

F4	32835	ISO-G 3/4" & SOLDER 16, TH = 20,1	CD000859
F3	32835	ISO-G 3/4" & SOLDER 16, TH = 20,1	CD000859
F2	32835	ISO-G 3/4" & SOLDER 16, TH = 20,1	CD000859
F1	32835	ISO-G 3/4" & SOLDER 16, TH = 20,1	CD000859

Pos	Article No	Title / Denomination, code, material, dimension etc	Drawing No./ref	Pos	Article No	Title / Denomination, code, material, dimension etc	Drawing No./ref
-----	------------	---	-----------------	-----	------------	---	-----------------

14626- 40

Title		B5TH/1P-SC-M	
 A DOVER COMPANY		Created Date	2017-06-28
		Created By	AU
Article/Configuration number		14626-040	
Drawing number		AU00282051	

Rev No.	Alteration	Date	Checked	Approved
1	CHANGED INNER DIAMETER	2007/09/17	ANL	PDM

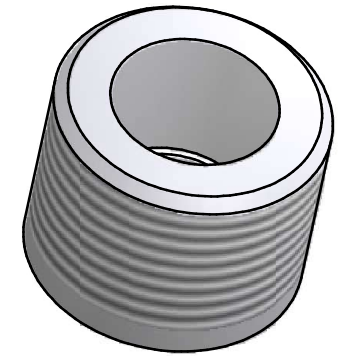
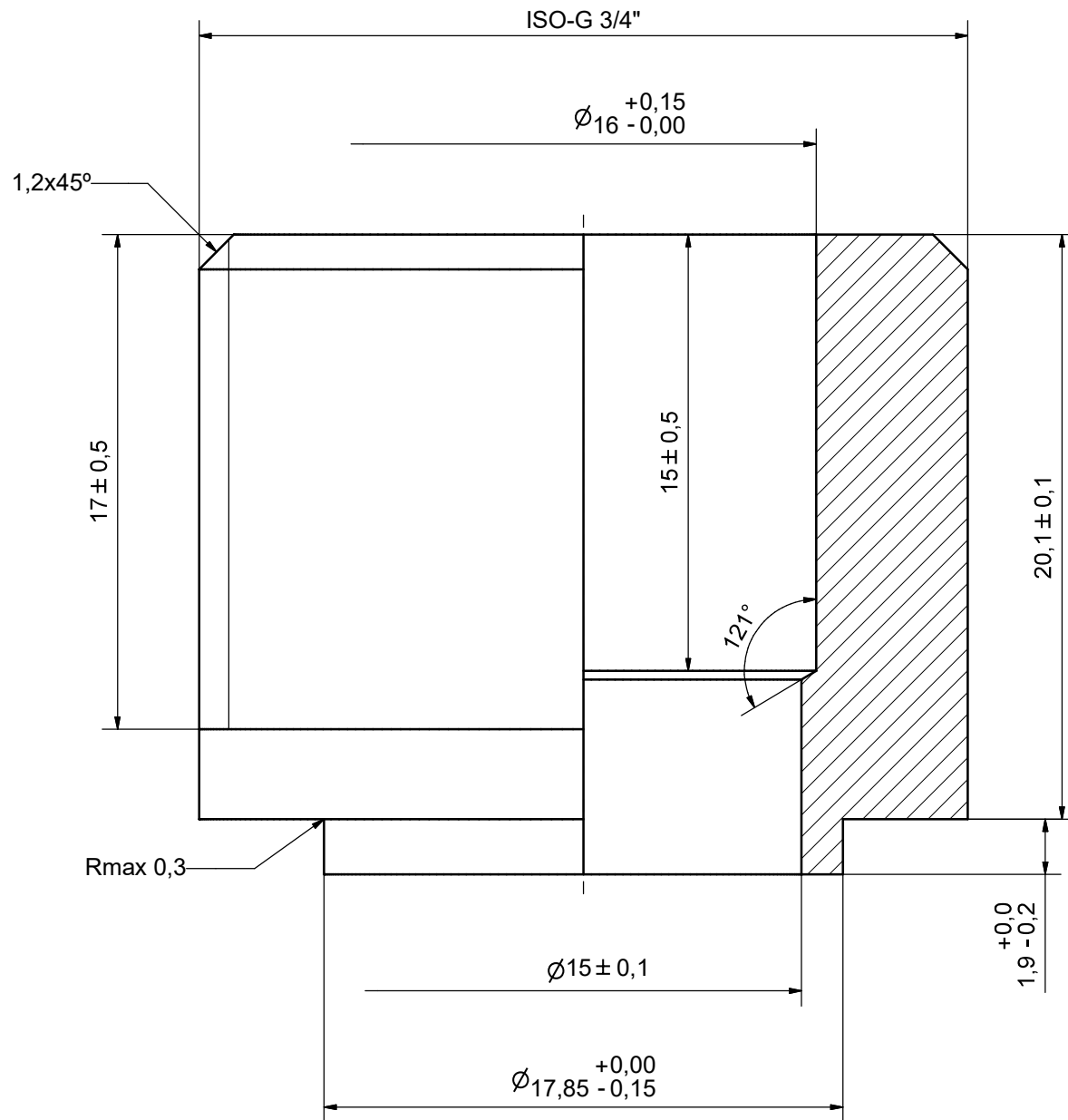

© Company Confidential, Property of SWEP International AB

**AXINTRA**  
ÉCHANGEURS THERMIQUES

ACCORDING TO MQS  
MATERIAL

Drawn	Checked	Approved	Created Date	General geometrical tolerancing ISO 2768	General surface finish $R_a$	Scale
ANL	PDM	PDM	2007/04/25	m	3.2	5:1
			<b>Title</b> ISO-G 3/4" & SOLDER 16			
<b>Article number</b> -		<b>Drawing number</b> CD000859		<b>Revision</b> 1	<b>Sheet</b> 1 (1)	