

B8T

Le B8T permet d'obtenir un échange thermique efficace dans des applications à faible débit qui exigent un espace restreint. Facile à installer et utiliser, ce produit est compact et polyvalent. C'est donc un bon choix pour diverses applications à une et deux phases, dans de nombreux secteurs industriels.



Spécifications de base

Nombre de plaques max. (NoP)	60
Débit volumétrique max.	4 m ³ /h (17.61 gpm)
Volume du canal	0.039/0.039 dm ³ (0.0014/0.0014 ft ³)
Matières	Plaques en acier inoxydable 316, brasage cuivre
Poids sans les connexions	0.85+(0.0749*NoP) kg 1.88+(0.165*NoP) lb

Les dimensions standard

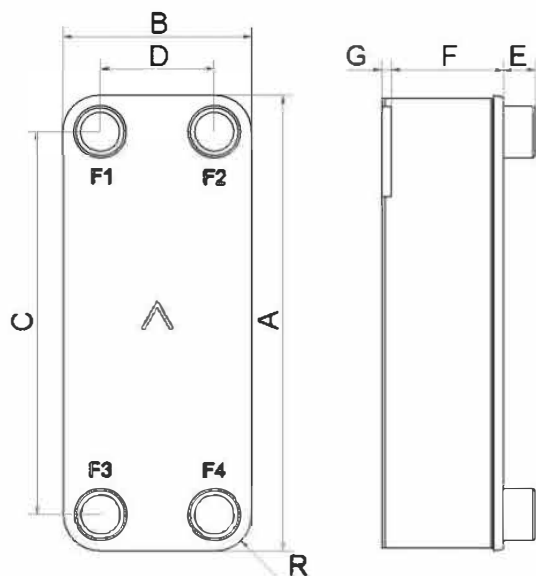

#	MM	IN
A	317	12.48
B	76	2.99
C	278	10.94
D	40	1.57
F	4.00+2.24*(NoP)	0.16+0.09*(NoP)
G	7	0.28
R	18	0.71
E_1	20	0.79

PED pression / température

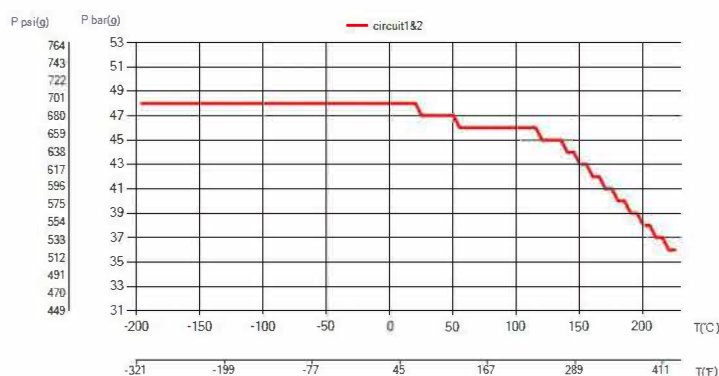

AXINTRA

ÉCHANGEURS THERMIQUES

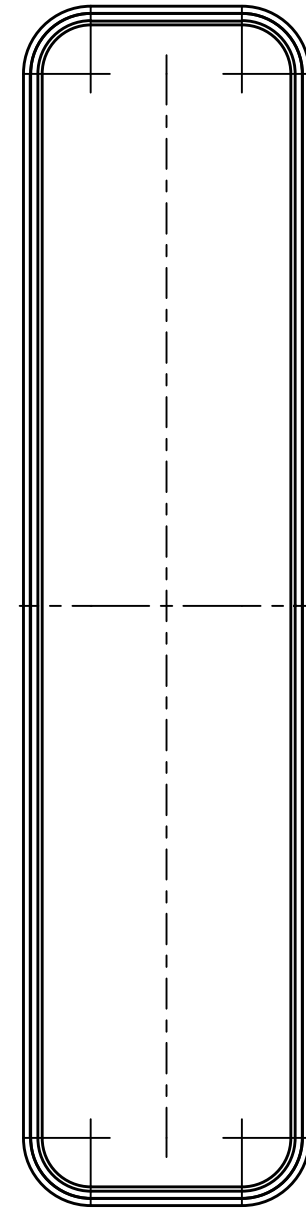
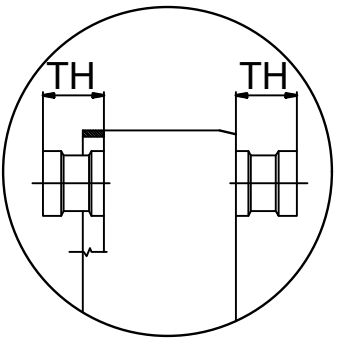
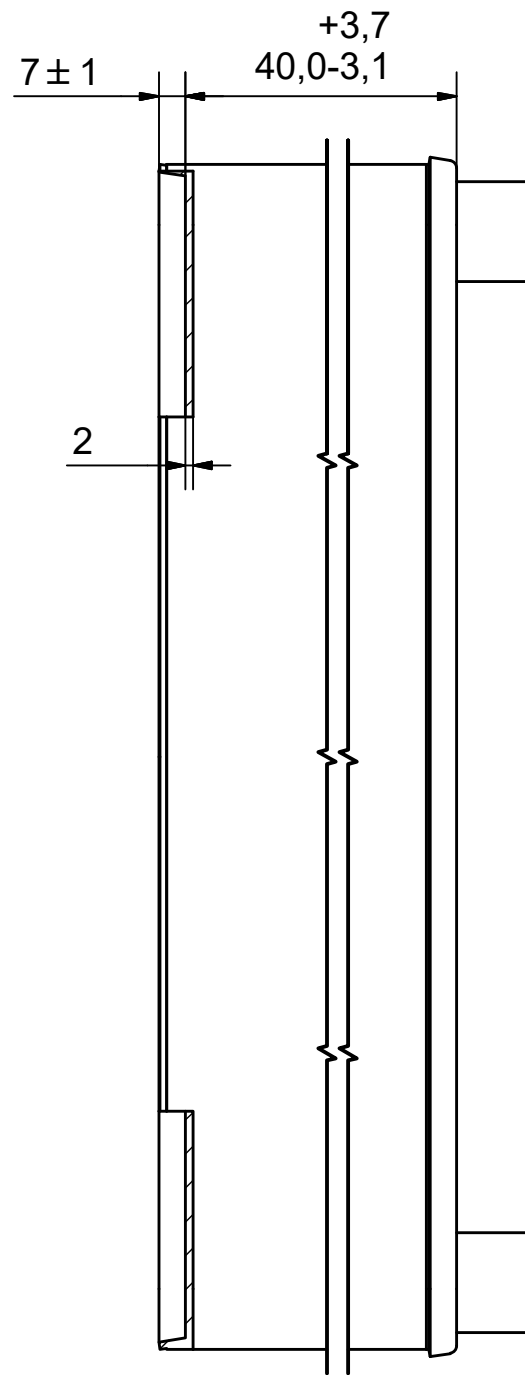
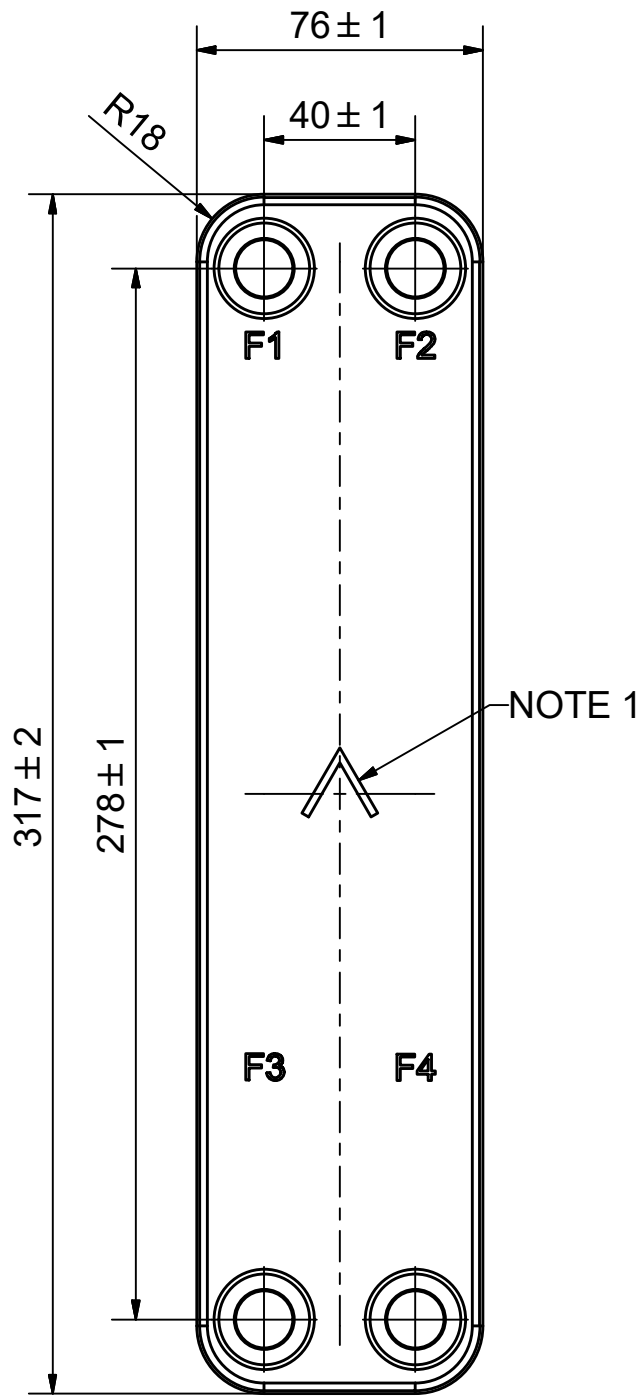

AXINTRA
ÉCHANGEURS THERMIQUES

NOTE 1 ALTERNATE MARKING: STICKER OR STAMP

F4	32835	ISO-G 3/4" & SOLDER 16, TH = 20,1	CD000859
F3	32835	ISO-G 3/4" & SOLDER 16, TH = 20,1	CD000859
F2	32835	ISO-G 3/4" & SOLDER 16, TH = 20,1	CD000859
F1	32835	ISO-G 3/4" & SOLDER 16, TH = 20,1	CD000859

Pos	Article No	Title / Denomination, code, material, dimension etc	Drawing No./ref	Pos	Article No	Title / Denomination, code, material, dimension etc	Drawing No./ref
-----	------------	---	-----------------	-----	------------	---	-----------------

Title		B8TH/1P-SC-M	
		Created Date	2019-02-06
		Created By	AU
Article/Configuration number		14361-016	
Drawing number		AU00459160	

Rev No.	Alteration	Date	Checked	Approved
1	CHANGED INNER DIAMETER	2007/09/17	ANL	PDM

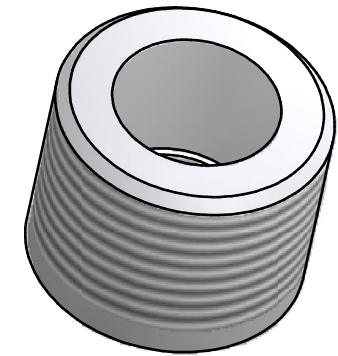
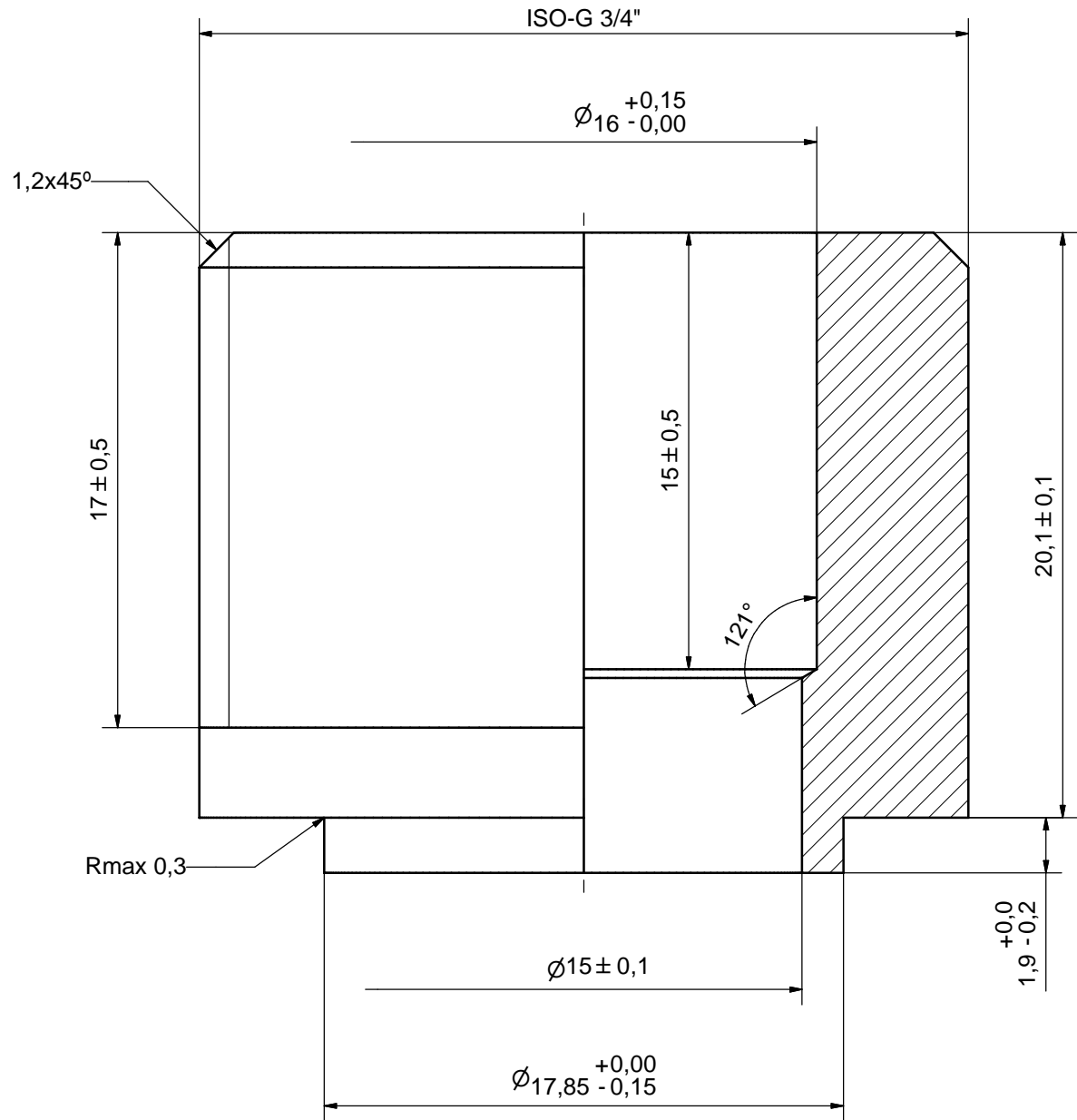

ACCORDING TO MQS
MATERIAL

Drawn	Checked	Approved	Created Date	General geometrical tolerancing ISO 2768	General surface finish R_a	Scale
ANL	PDM	PDM	2007/04/25	m	3.2	5:1
SUPER A DOVER COMPANY						
Title			ISO-G 3/4" & SOLDER 16			
Article number		Drawing number		Revision	Sheet	
-		CD000859		1	1 (1)	

© Company Confidential, Property of SWEP International AB

AXINTRA
ÉCHANGEURS THERMIQUES