

B10T

Le B10T offre des solutions d'échange thermique dans un large éventail de capacités. Son adaptation à de nombreuses applications est rapide et simple. Par sa compacité, sa polyvalence, son excellent transfert thermique, ce produit est le choix idéal pour des applications monophasiques et de réfrigération.

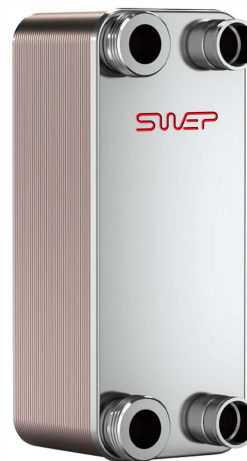

Spécifications de base

Nombre de plaques max. (NoP)	140
Débit volumétrique max.	9 m ³ /h (39.63 gpm)
Volume du canal	0.061/0.061 dm ³ (0.0022/0.0022 ft ³)
Matières	Plaques en acier inoxydable 316, brasage cuivre
Poids sans les connexions	1.15+(0.096*NoP) kg 2.54+(0.212*NoP) lb

Les dimensions standard

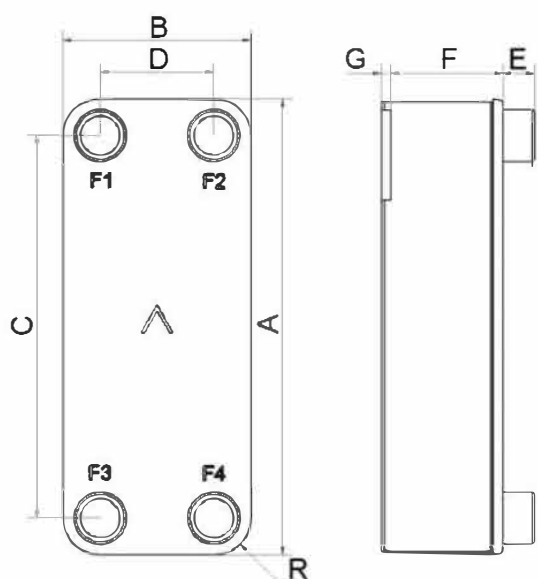

#	MM	IN
A	289	11.38
B	119	4.69
C	243	9.57
D	72	2.83
F	4.00+2.24*(NoP)	0.16+0.09*(NoP)
G	6	0.24
R	22	0.87
E_1	20	0.79

PED pression / température

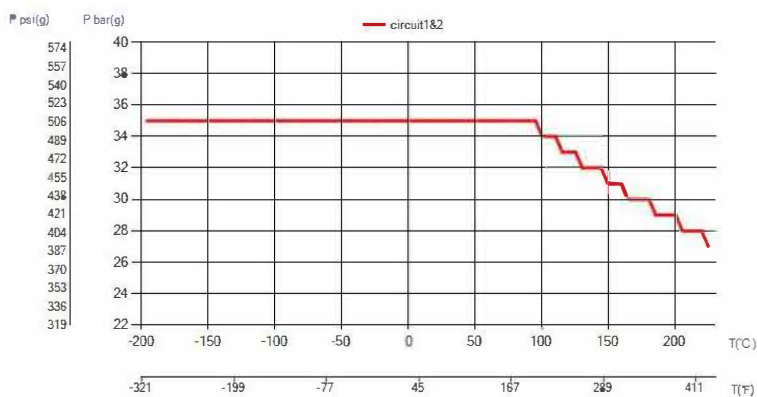

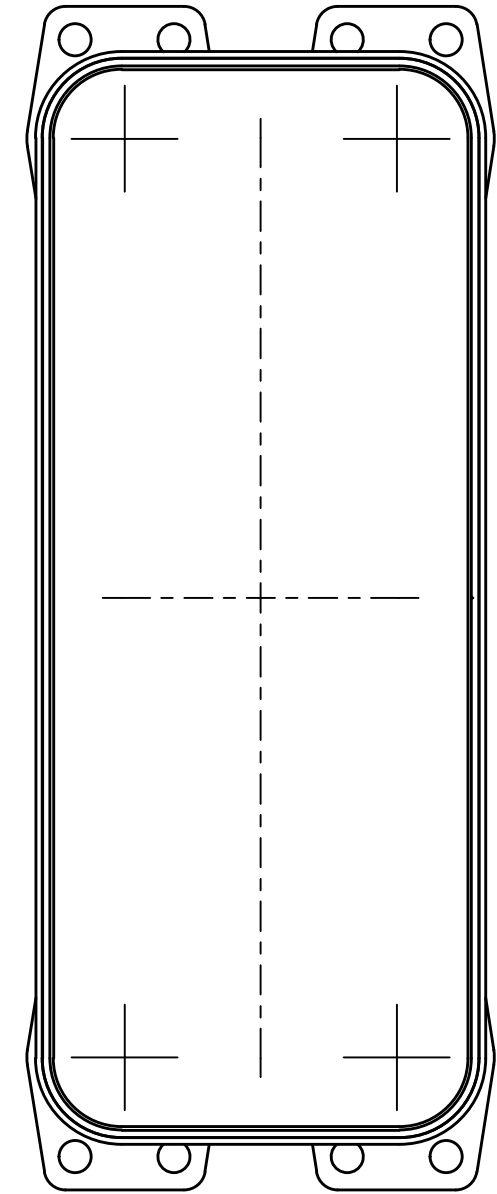
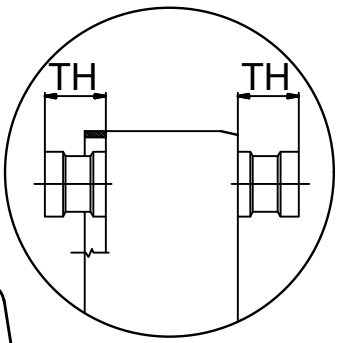
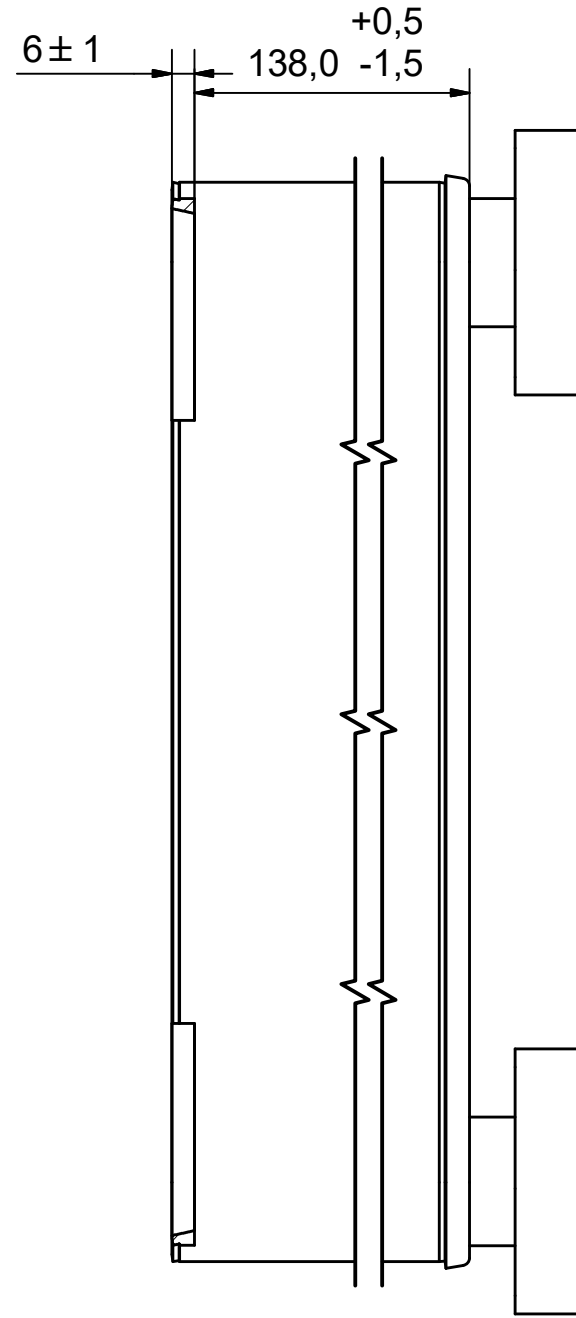
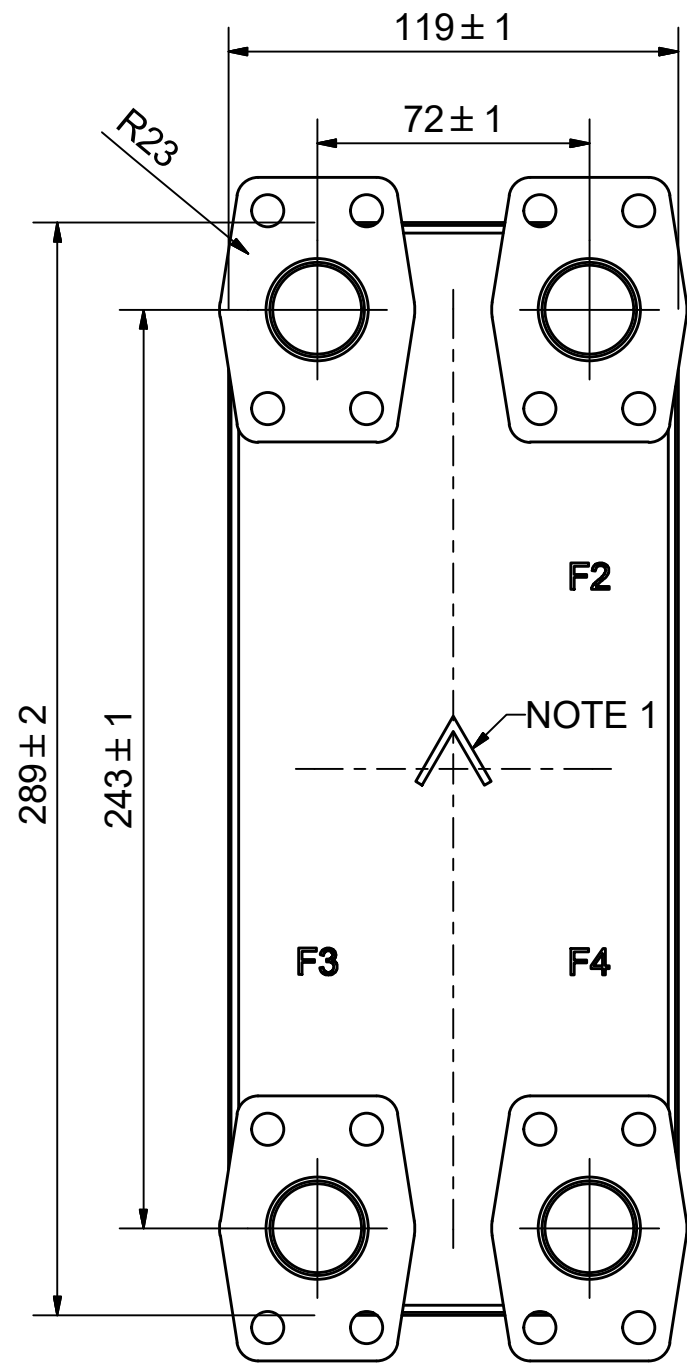

AXINTRA
ÉCHANGEURS THERMIQUES

NOTE 1 ALTERNATE MARKING: STICKER OR STAMP

F4	45712	SAE-1, TH = 30	CD000239
F3	45712	SAE-1, TH = 30	CD000239
F2	45712	SAE-1, TH = 30	CD000239
F1	45712	SAE-1, TH = 30	CD000239

Pos	Article No	Title / Denomination, code, material, dimension etc	Drawing No./ref	Pos	Article No	Title / Denomination, code, material, dimension etc	Drawing No./ref
-----	------------	---	-----------------	-----	------------	---	-----------------

Title		B10TH/1P-SC-S	
 A DOVER COMPANY		Created Date	2018-01-03
		Created By	AU
Article/Configuration number		13824-060	
Drawing number		AU00330291	

Rev No.	Alteration	Date	Checked	Approved
5	ADDED CENTER LINES IN BASIC VIEW	2005/11/29	THE	PDM

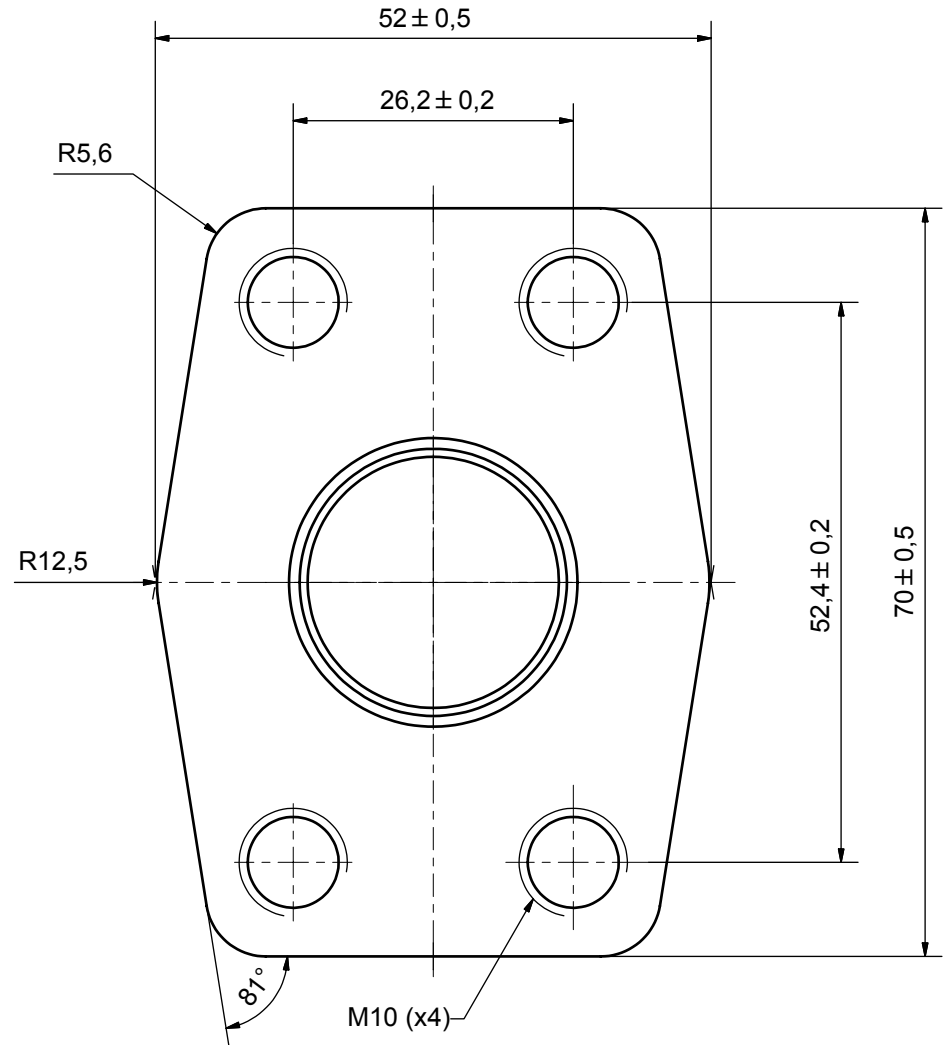
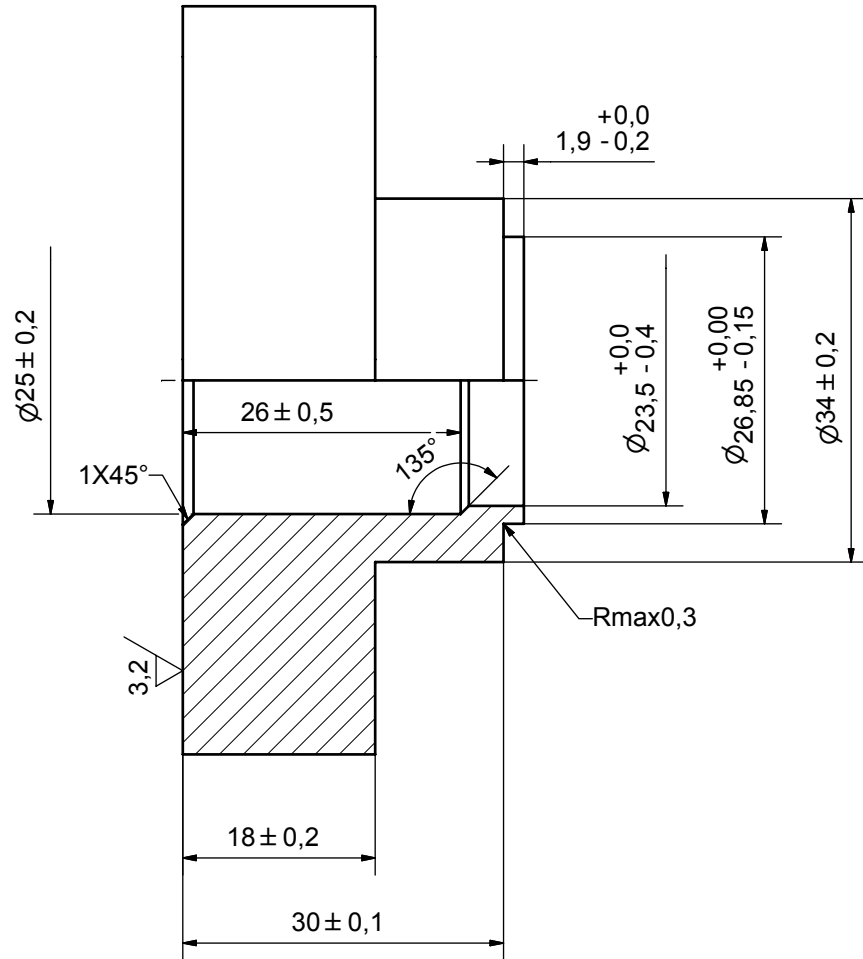
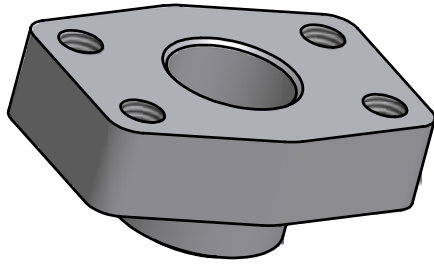

© Company Confidential, Property of SWEP International AB

AXINTRA
ÉCHANGEURS THERMIQUES

Drawn HR	Checked TOD	Approved BOS	Created Date 1995/10/26	General geometrical tolerancing ISO 2768 m	General surface finish R_a 3.2	Scale 2:1
Title SAE-1			Article number -	Drawing number CD000239	Revision 5	Sheet 1 (1)

