

B16

Le B16 a été spécialement conçu pour les applications monophasiques. Il est aussi adapté aux capacités et spécifications des sous-stations de chauffage urbain, des circuits de radiateurs, des applications de chauffage d'eau potable. Le B16 est aussi un excellent choix pour le refroidissement d'huile.



Spécifications de base

Nombre de plaques max. (NoP)	140
Débit volumétrique max.	16,9 m³/h (39.63 gpm)
Volume du canal	0.082/0.082 dm³ (0.0029/0.0029 ft³)
Matières	Plaques en acier inoxydable 316, brasage cuivre
Poids sans les connexions	1.48+(0.12*NoP) kg 3.25+(0.265*NoP) lb

Les dimensions standard

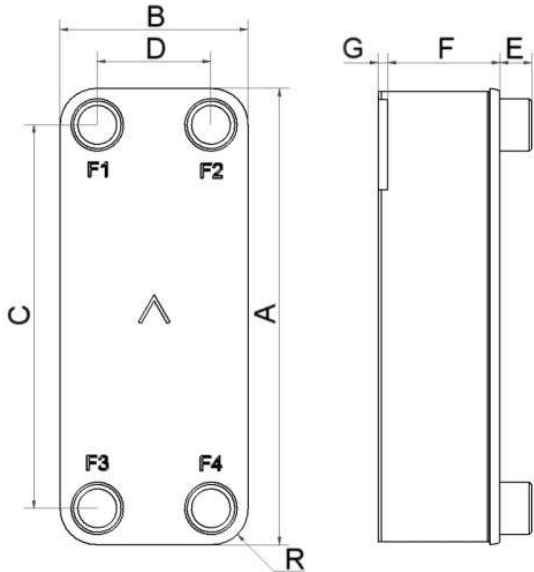

#	MM	IN
A	376	14.8
B	119	4.69
C	320	12.6
D	63	2.48
F	4.00+2.24*(NoP)	0.16+0.09*(NoP)
G	6	0.24
R	23	0.91
E_1	27	1.06

PED pression / température

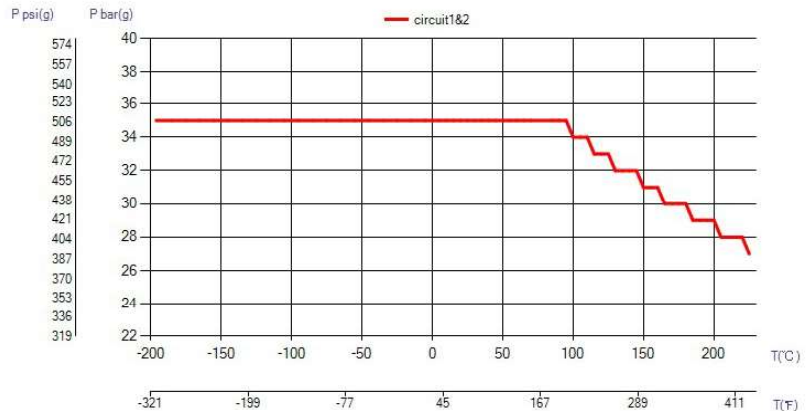

ÉCHANGEURS THERMIQUES

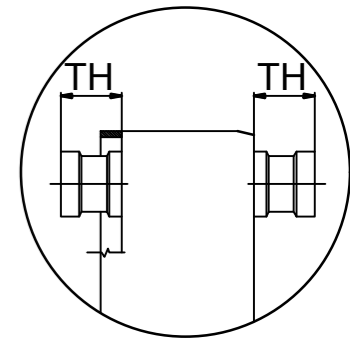
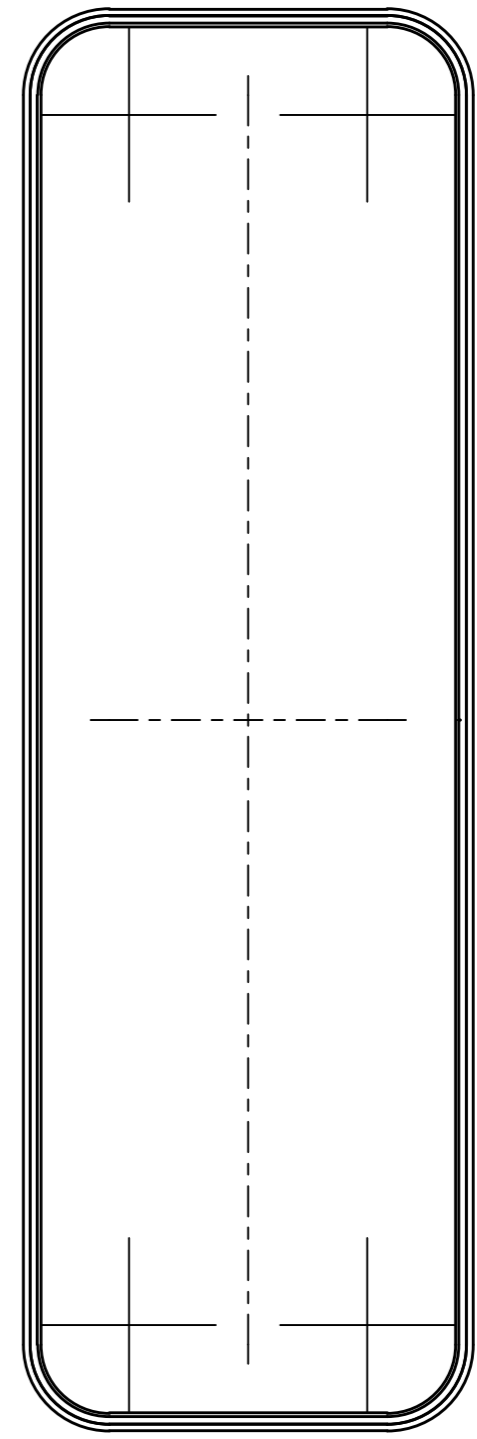
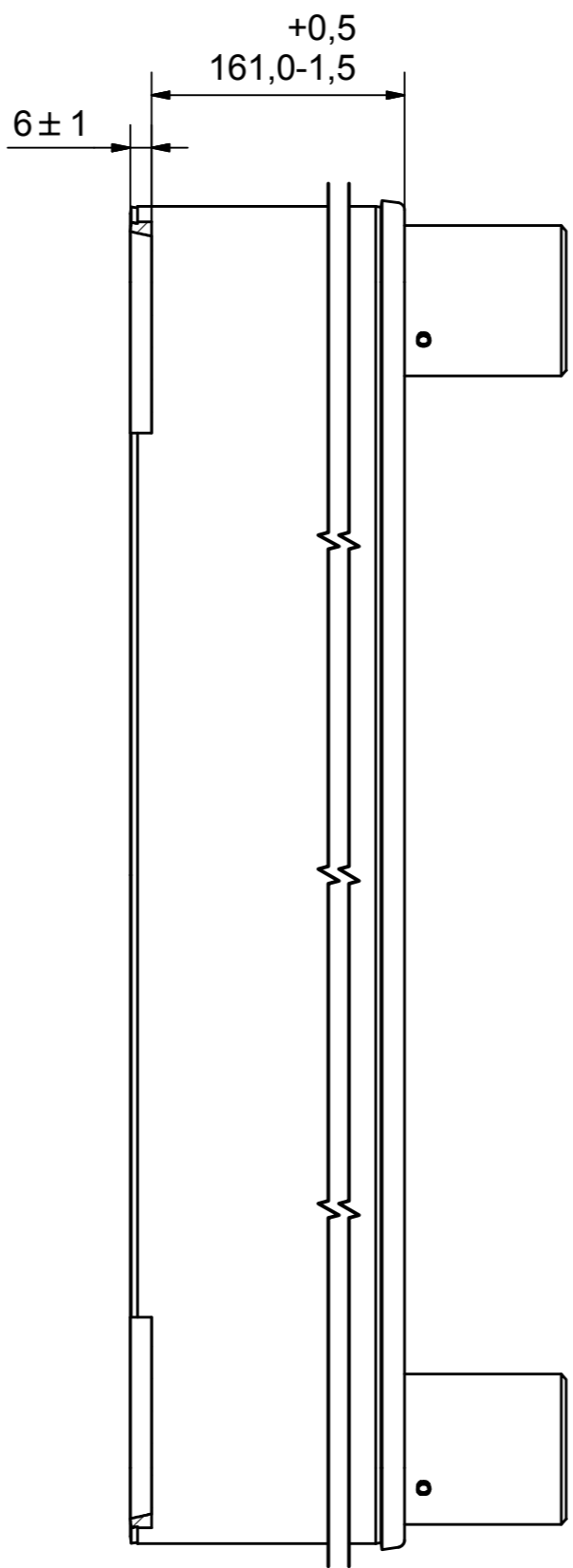
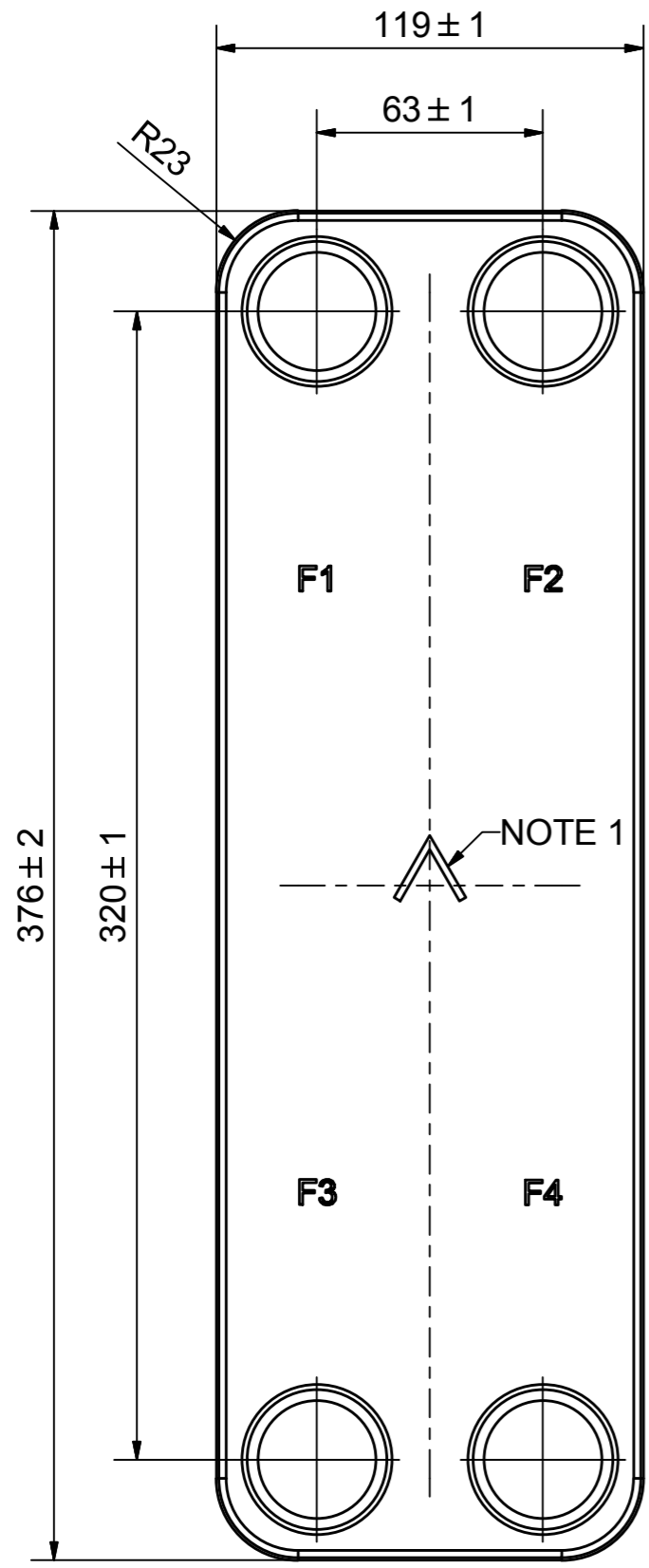



AXINTRA

ÉCHANGEURS THERMIQUES

NOTE 1 ALTERNATE MARKING: STICKER OR STAMP

F4	36122	ISO-G 1 1/4", TH = 45,1	CD001434
F3	36122	ISO-G 1 1/4", TH = 45,1	CD001434
F2	36122	ISO-G 1 1/4", TH = 45,1	CD001434
F1	36122	ISO-G 1 1/4", TH = 45,1	CD001434

Title		B16H/1P-SC-S	
 A DOVER COMPANY	Created Date	Created By	
	2018-04-16	AU	
	Article/Configuration number	Drawing number	
	14870-070	AU00368231	

Pos	Article No	Title / Denomination, code, material, dimension etc	Drawing No./ref	Pos	Article No	Title / Denomination, code, material, dimension etc	Drawing No./ref
-----	------------	---	-----------------	-----	------------	---	-----------------

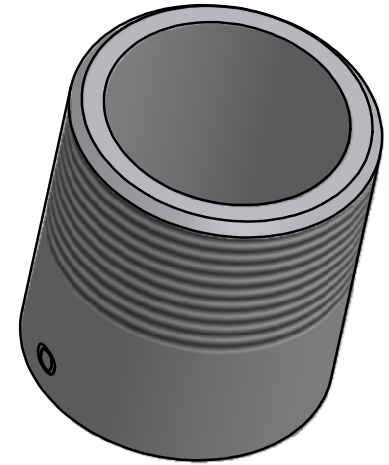
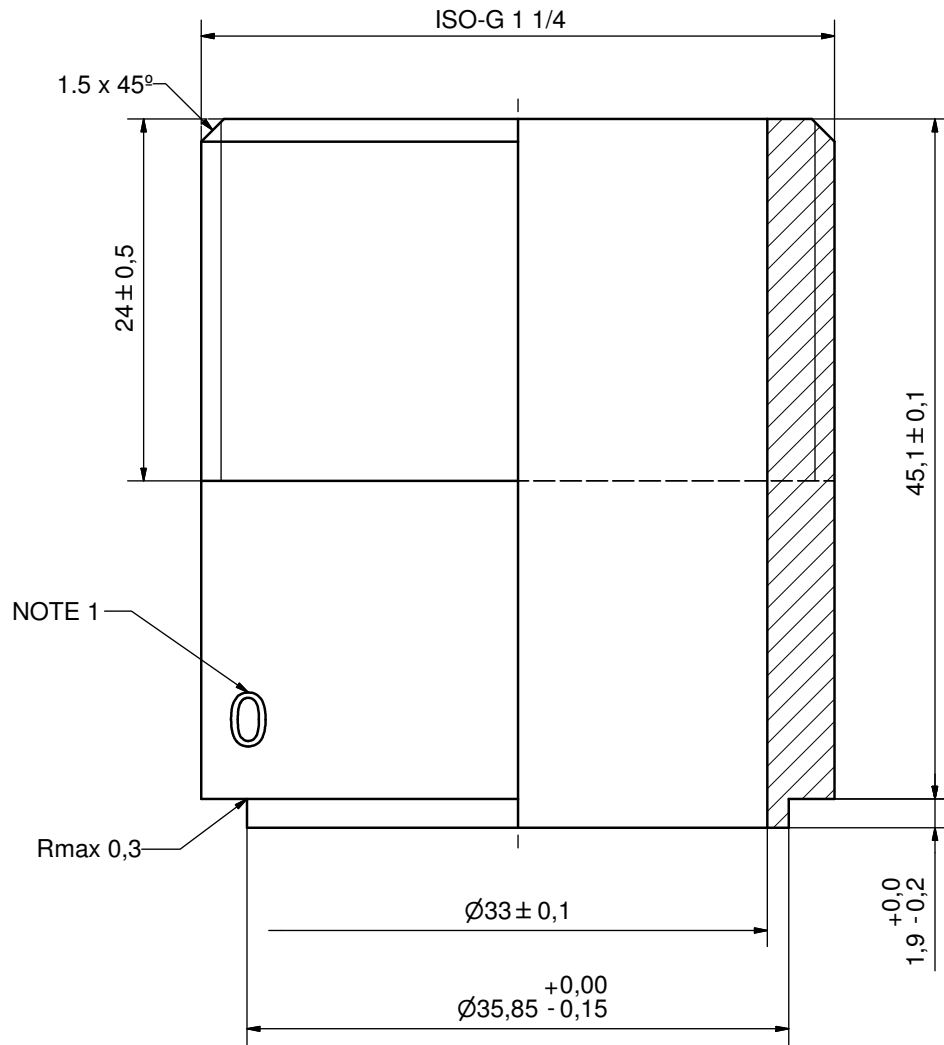

NOTE 1: MARKING TEXT "0" FOR IDENTIFICATION ONLY.
PRESENT AT 2 PLACES 180° FROM EACH OTHER
"0" = 304 MATERIAL

DEBURR SHARP EDGES; MAX 0,4

ACCORDING TO MQS
MATERIAL

Drawn	Checked	Approved	Created Date	General geometrical tolerancing ISO 2768	General surface finish Ra	Scale
AP	PDM	PDM	4/18/2011	m	3.2	-
			Title			
			ISO-G 1 1/4"			
Article number		DesignType	Drawing number	Revision	Sheet	
-			CD001434	00	1 (1)	