

B85

Le B85 est un échangeur thermique extrêmement performant. La performance thermique du B85 est supérieure à celle de tout autre produit comparable. Le B85 est le choix idéal pour les condensateurs à haute performance et les applications de transfert thermique exigeantes. Ses larges ports lui permettent d'accepter des capacités élevées. Avec sa profondeur de pressage inférieure à celle des générations précédentes, fait que le B85 est plus compact et performant.



Spécifications de base

Nombre de plaques max. (NoP)	160
Débit volumétrique max.	17 m ³ /h (74.85 gpm)
Volume du canal	0.094/0.094 dm ³ (0.0033/0.0033 ft ³)
Matières	Plaques en acier inoxydable 316, brasage cuivre
Poids sans les connexions	2.09+(0.1367*NoP) kg 4.60+(0.301*NoP) lb

Les dimensions standard

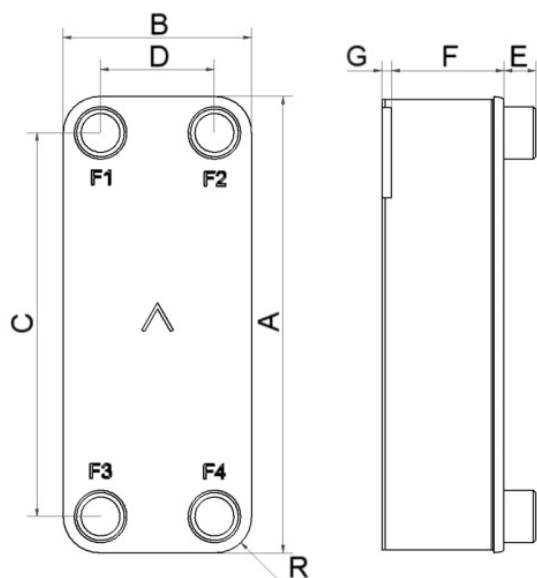

#	MM	IN
A	526	20.71
B	119	4.69
C	470	18.5
D	63	2.48
F	4,00+1,84*(NoP)	15.75+7.24*(NoP)
G	6	0.24
R	23	0.91
E_1	27	1.06

PED pression / température

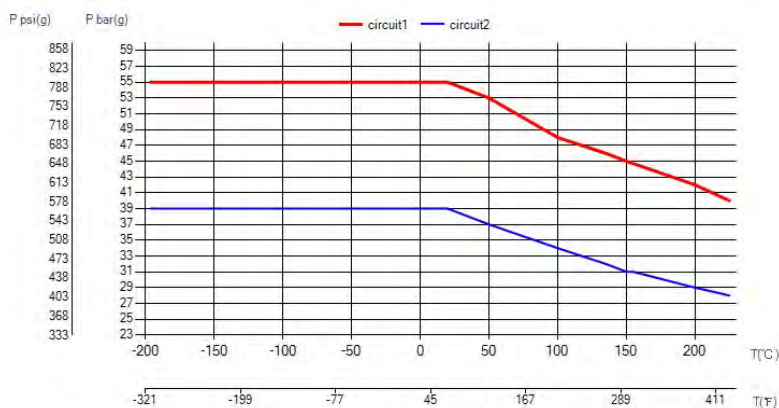

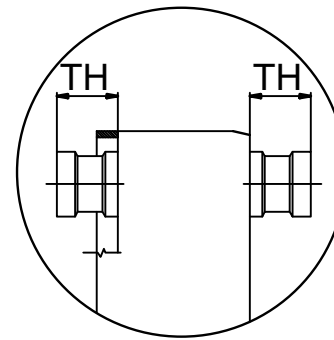
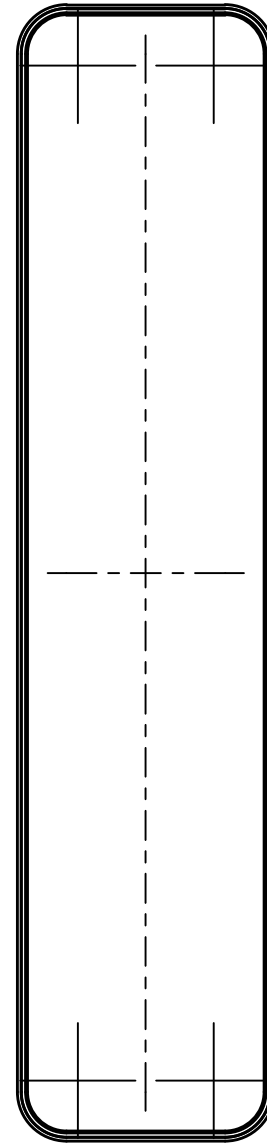
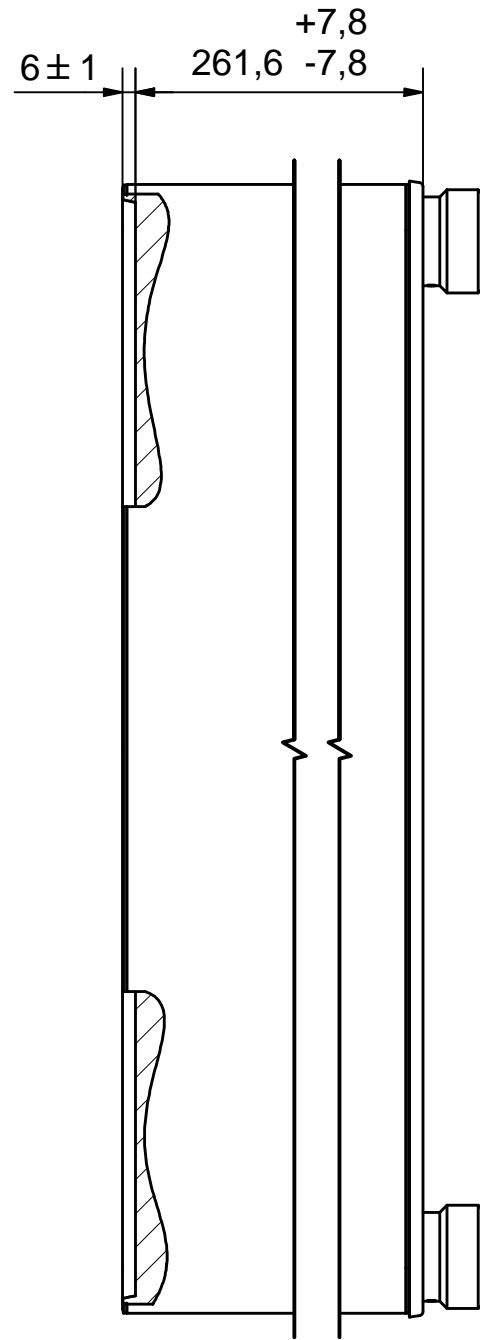
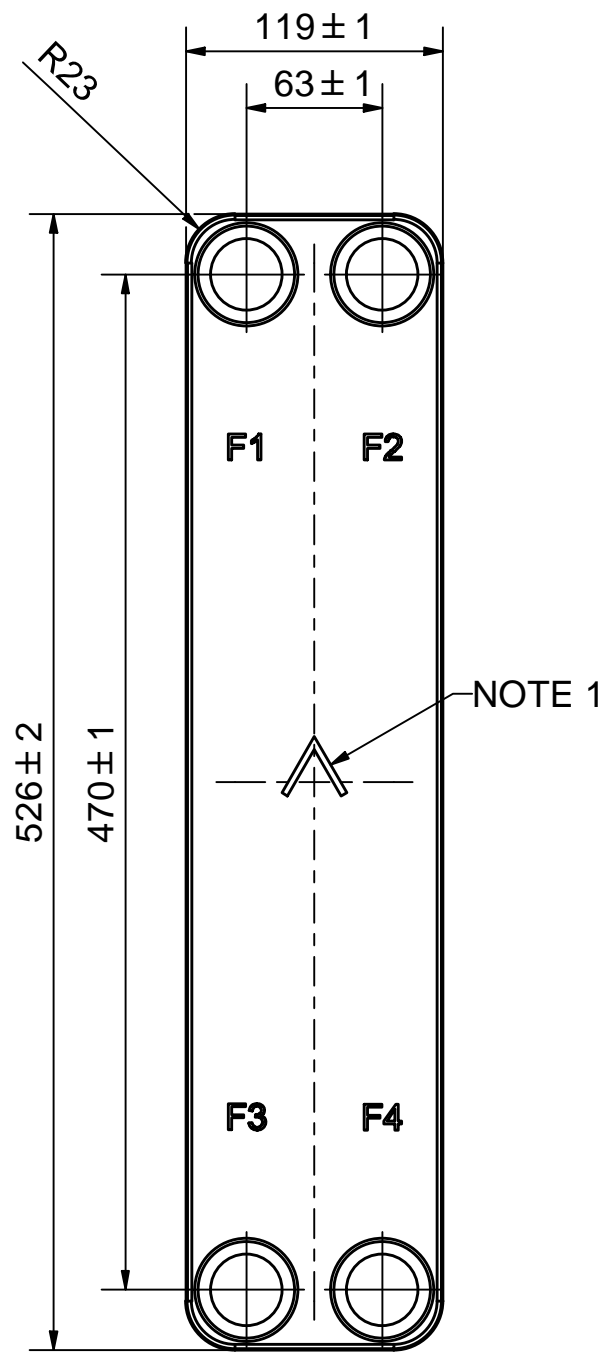

AXINTRA
ÉCHANGEURS THERMIQUES

NOTE 1: ALTERNATE MARKING: STICKER OR STAMP

F4	36175	ISO-G 1 1/2 A, TH = 27,1	CD001468
F3	36175	ISO-G 1 1/2 A, TH = 27,1	CD001468
F2	36175	ISO-G 1 1/2 A, TH = 27,1	CD001468
F1	36175	ISO-G 1 1/2 A, TH = 27,1	CD001468

Pos	Article No	Title / Denomination, code, material, dimension etc	Drawing No./ref	Pos	Article No	Title / Denomination, code, material, dimension etc	Drawing No./ref
-----	------------	---	-----------------	-----	------------	---	-----------------

Title		B85Hx140/1P-SC-M 4x1 1/2"	
 A DOVER COMPANY		Created Date	2024-08-29
		Created By	AU
Article/Configuration number		0221865.0	
Drawing number		AU00057310_0221865.0	

Rev No	Alteration	Date	Checked	Approved
01	Removed thread length dim, Added 7.7mm & Added Critical character	2014-10-14	inskp	PDM

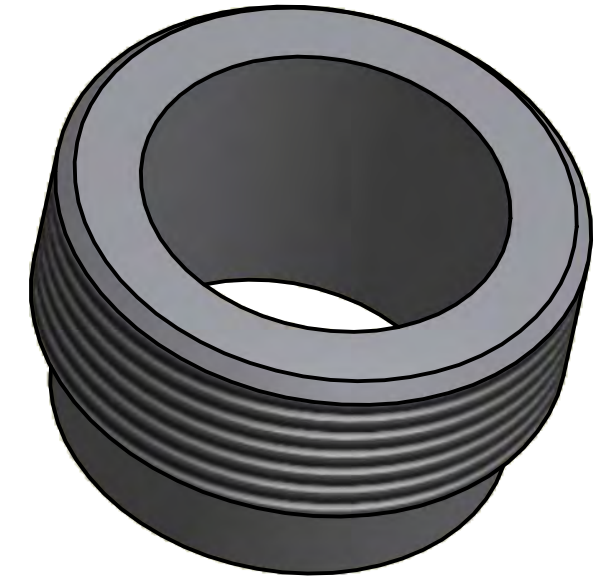
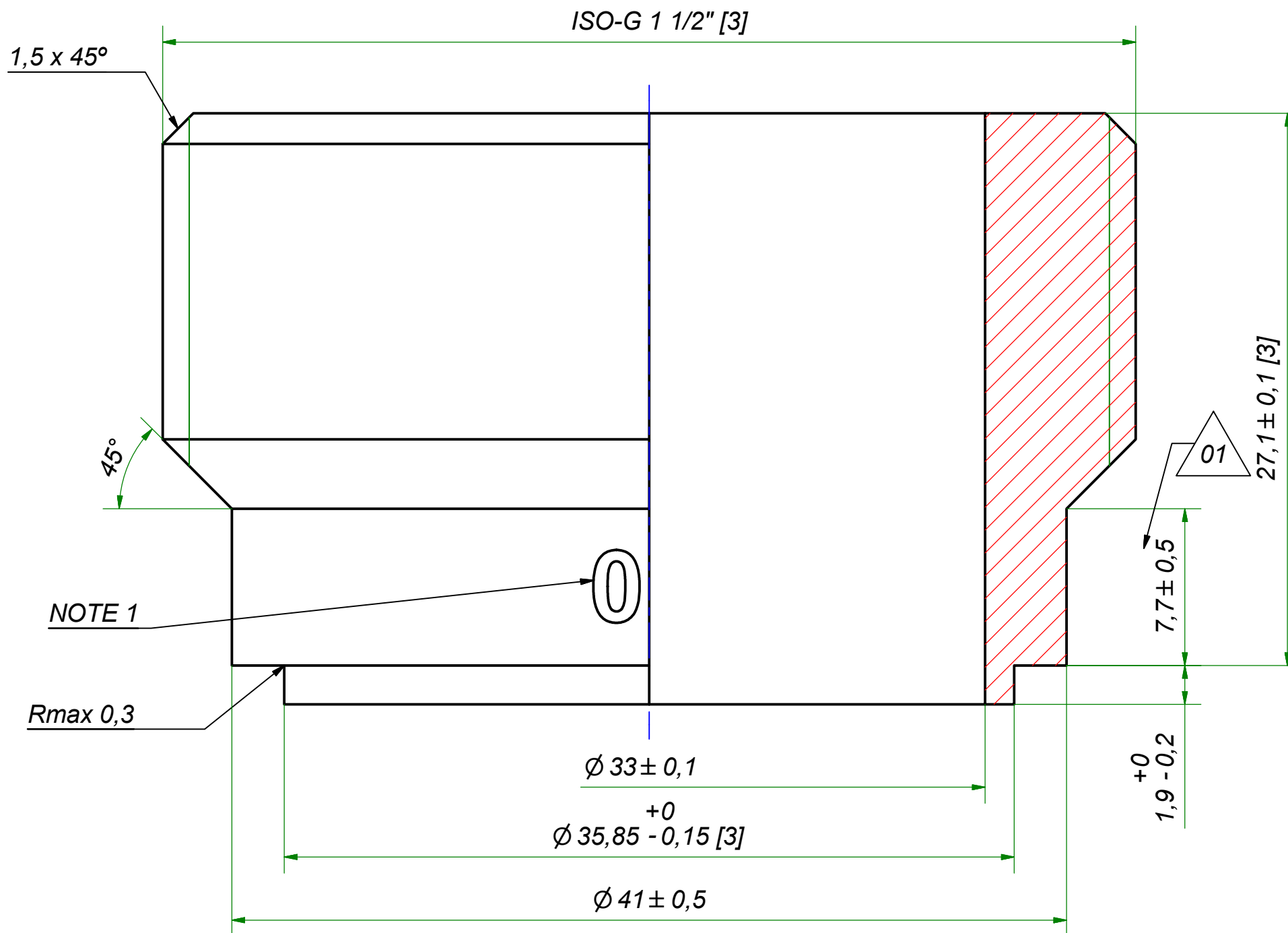

NOTE 3: [3] - CRITICAL/SPECIAL CHARACTERISTIC TO BE FOLLOWED
NOTE 2: MARKING TEXT "0" FOR IDENTIFICATION ONLY
PRESENT AT 2 PLACES 180° FROM EACH OTHER
"0" = 304 MATERIAL

NOTE 1: DEBURR SHARP EDGES; MAX 0.4

ACCORDING TO MQS
MATERIAL

Drawn skmzp	Checked PDM	Approved PDM	Created Date 2011-06-13	General geometrical tolerancing ISO 2768: m	General surface finish R_a : 3.2	Scale -	Paper size A3
 A DOVER COMPANY			Title ISO-G 1 1/2				
			Article number CD	Design Type CD	Drawing number CD001468	Revision 01	Sheet 1 (1)